

# Si photodiode arrays

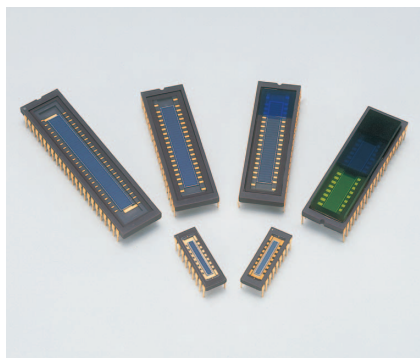

## S4111/S4114 series

### 16, 35, 46 element Si photodiode array for UV to NIR

The S4111/S4114 series are Si photodiode linear array mounted in ceramic DIPs (Dual Inline Packages). These photodiode arrays are primarily developed for low-light-level detection such as spectrophotometry, and cover a wide spectral range from UV to near infrared light. Since all elements can be used with a reverse bias for charge storage readout, the S4111/S4114 series are able to detect low level light with high sensitivity. Crosstalk between elements is minimized to maintain signal purity. Special filters can be attached as the input window (custom order products).

#### Features

- Large photosensitive area
- Low crosstalk
- S4111 series: Enhanced infrared sensitivity, low dark current
- S4114 series: IR sensitivity suppressed type, low terminal capacitance, high-speed response

#### Applications

- Multichannel spectrophotometers
- Color analyzers
- Light spectrum analyzers
- Light position detection

#### Structure / Absolute maximum ratings

Type no.	Window material	Package (mm)	Photosensitive area (per 1 element)		Between elements measure (mm)	Between elements pitch (mm)	Number of elements	Absolute maximum ratings					
			Size (mm)	Effective area (mm <sup>2</sup> )				Reverse voltage V <sub>R</sub> max (V)	Operating temperature T <sub>opr</sub> (°C)	Storage temperature T <sub>stg</sub> (°C)			
S4111-16R	Resin potting	18 pin DIP	1.45 × 0.9	1.305	0.1	1.0	16	15	-20 to +60	-20 to +80			
S4111-16Q*													
S4111-35Q*	Quartz	40 pin DIP	4.4 × 0.9	3.96							35		
S4111-46Q*		48 pin DIP										46	
S4114-35Q*		40 pin DIP											35
S4114-46Q*		48 pin DIP											

\* Refer to "Precautions against UV light exposure."

Note: Absolute maximum ratings are the values that must not be exceeded at any time. If even one of the absolute maximum ratings is exceeded even for a moment, the product quality may be impaired. Always be sure to use the product within the absolute maximum ratings.

#### Electrical and optical characteristics (Typ. T<sub>a</sub>=25 °C, per 1 element, unless otherwise noted)

Type no.	Spectral response range λ (nm)	Peak sensitivity wavelength λ <sub>p</sub> (nm)	Photosensitivity S			Dark current I <sub>D</sub> Max.		Shunt resistance R <sub>sh</sub> V <sub>R</sub> =10 mV		Terminal capacitance C <sub>t</sub>		Rise time t <sub>r</sub> R <sub>L</sub> =1 kΩ λ=655 nm		NEP λ=λ <sub>p</sub>	
			λ <sub>p</sub> (A/W)	200 nm (A/W)	633 nm (A/W)	V <sub>R</sub> =10 mV (pA)	V <sub>R</sub> =10 V (pA)	Min (GΩ)	Typ. (GΩ)	V <sub>R</sub> =0 V (pF)	V <sub>R</sub> =10 V (pF)	V <sub>R</sub> =0 V (μs)	V <sub>R</sub> =10 V (μs)	V <sub>R</sub> =0 V (W/Hz <sup>1/2</sup> )	V <sub>R</sub> =10 V (W/Hz <sup>1/2</sup> )
S4111-16R	340 to 1100	960	0.58	-	0.39	5	25	2.0	250	200	50	0.5	0.1	4.4 × 10 <sup>-16</sup>	1.7 × 10 <sup>-15</sup>
S4111-16Q				0.08	0.43										
S4111-35Q	190 to 1100	960	0.58	0.08	0.43	10	50	1.0	30	550	120	1.2	0.3	1.3 × 10 <sup>-15</sup>	3.1 × 10 <sup>-15</sup>
S4111-46Q															
S4114-35Q	190 to 1000	800	0.50	0.08	0.43	60	300	0.15	2	35	20	0.1	0.05	5.7 × 10 <sup>-15</sup>	8.0 × 10 <sup>-15</sup>
S4114-46Q															

**Spectral response**

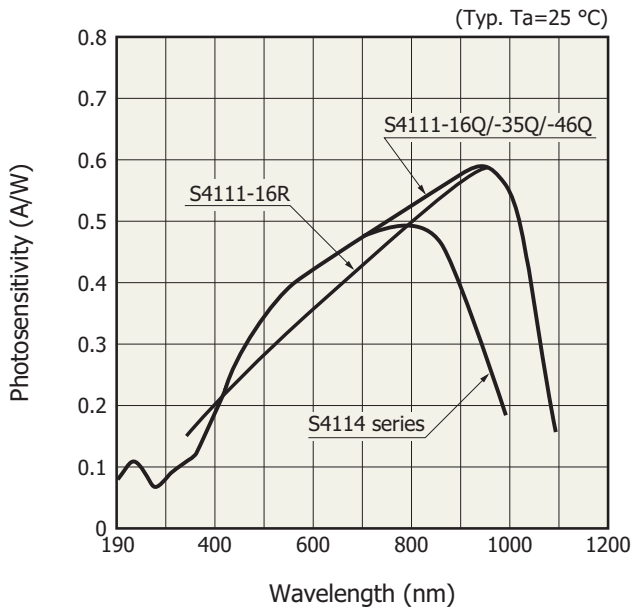

KMPDB0112EB

**Photo sensitivity temperature characteristics**

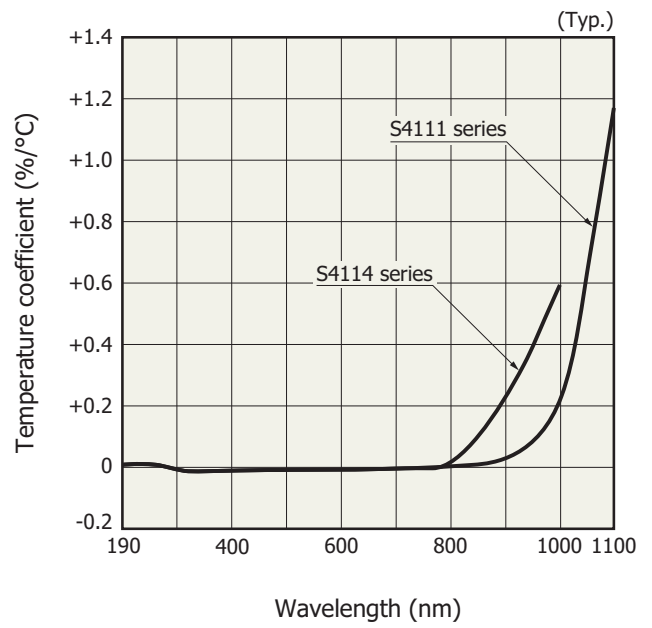

KMPDB0113EA

**Dark current vs. reverse voltage**

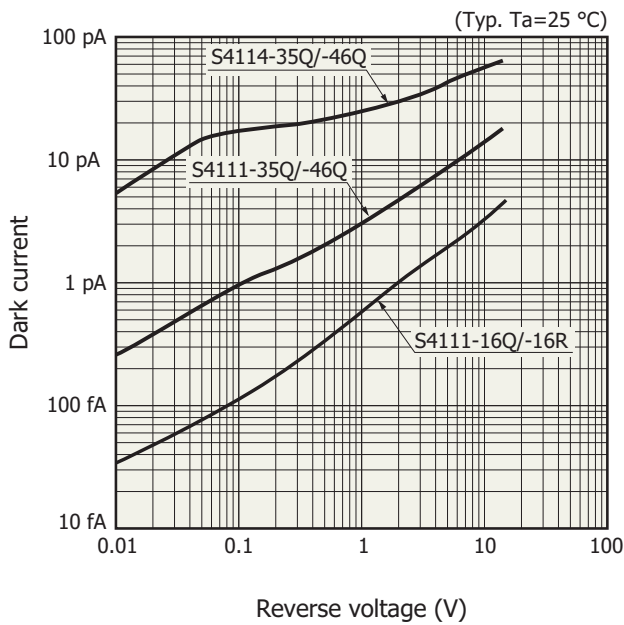

KMPDB0114EA

**Terminal capacitance vs. reverse voltage**

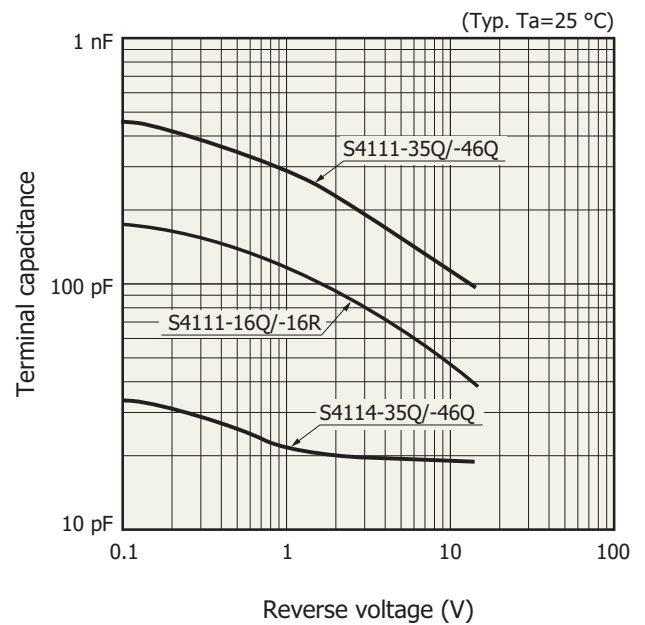

KMPDB0115EA

Example of crosstalk

S4111 series

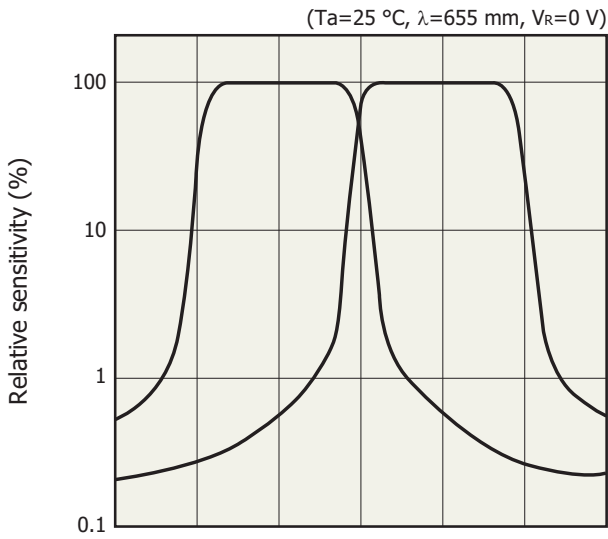

Light position on photosensitive area (500  $\mu\text{m}/\text{div.}$ )

KMPD80015EA

S4114 series

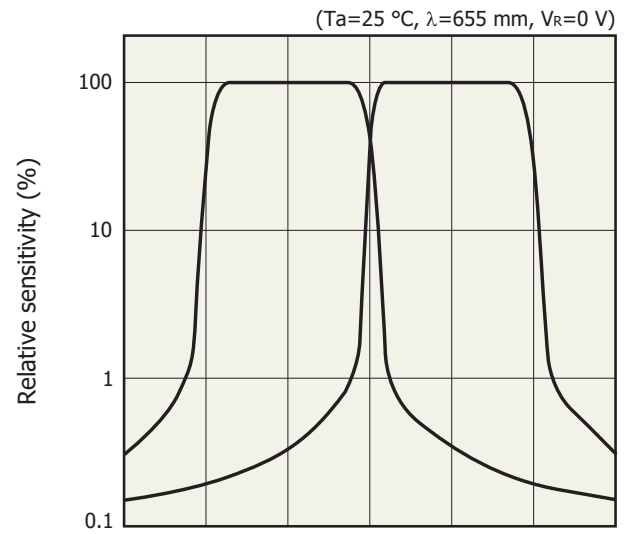

Light position on photosensitive area (500  $\mu\text{m}/\text{div.}$ )

KMPD80018EB

Dimensional outline (unit: mm)

S4111-16R

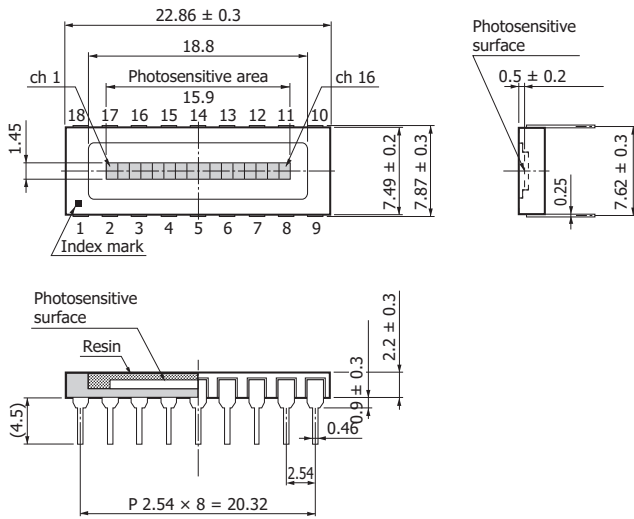

KMPDA0136EB

S4111-16Q

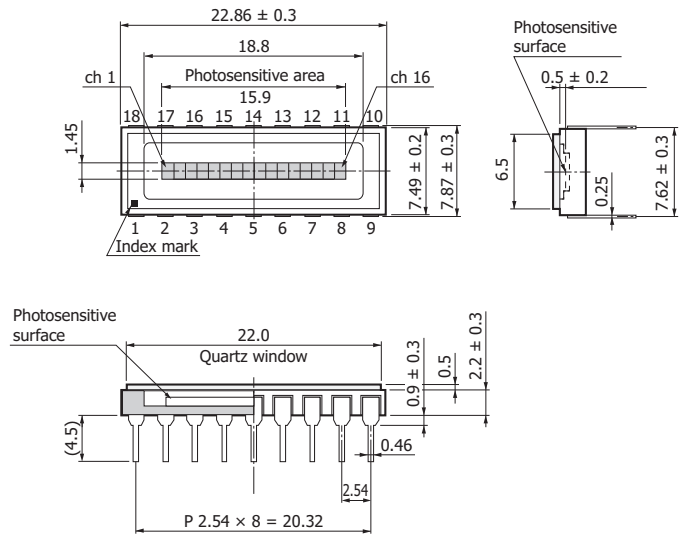

KMPDA0135EB

S4111-35Q, S4114-35Q

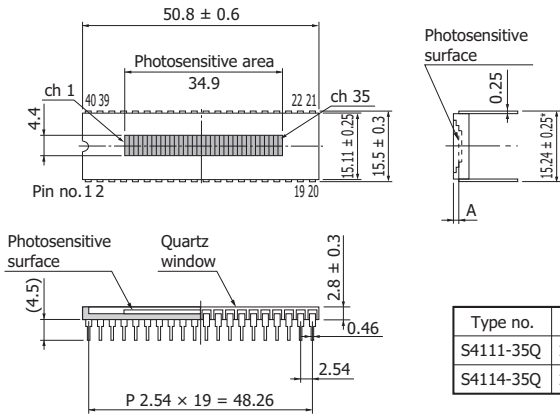

KMPDA0019ED

S4111-46Q, S4114-46Q

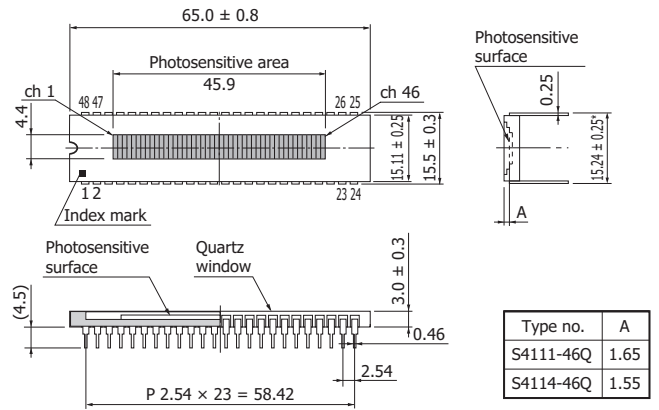

KMPDA0021ED

Details of elements (for all types)

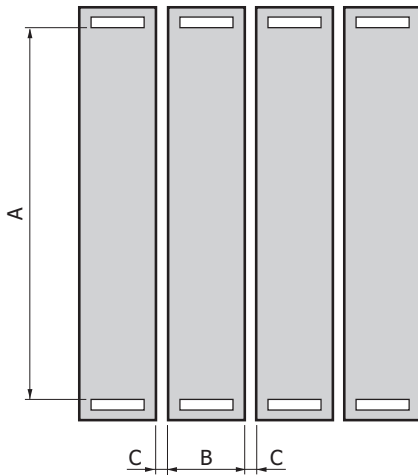

	A	B	C
S4111-16Q/16R	1.45	0.9	0.1
S4111-35Q/46Q S4114-35Q/46Q	4.4	0.9	0.1

KMPDA0112EA

### Pin connections

Pin no.	16-element type	35-element type	46-element type
1	KC	KC	KC
2	2	2	2
3	4	4	4
4	6	6	6
5	8	8	8
6	10	10	10
7	12	12	12
8	14	14	14
9	16	16	16
10	KC	18	18
11	15	NC	20
12	13	20	22
13	11	22	24
14	9	24	26
15	7	26	28
16	5	28	30
17	3	30	32
18	1	32	34
19		34	36
20		NC	38
21		KC	40
22		35	42
23		33	44
24		31	46
25		29	KC
26		27	45
27		25	43
28		23	41
29		21	39
30		19	37
31		17	35
32		15	33
33		13	31
34		11	29
35		9	27
36		7	25
37		5	23
38		3	21
39		1	19
40		NC	17
41			15
42			13
43			11
44			9
45			7
46			5
47			3
48			1

### Operating circuits

- ① In the most generally used circuit, operational amplifiers are connected to each channel to read the output in real time. The output of an operational amplifier is of low impedance and thus can be easily multiplexed.

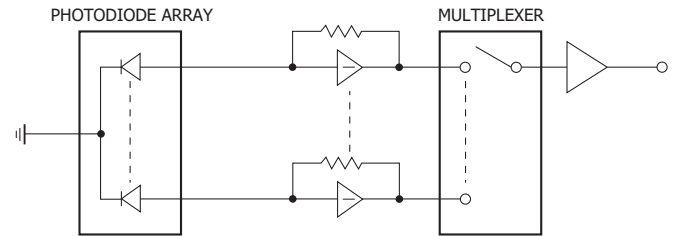

- ② In the charge storage readout method, the charge stored in the junction capacitance of each channel, which is proportional to the incident light intensity, can be read out in sequence by a multiplexer. With this method, reverse voltage must be applied to the photodiodes, so S4111 and S4114 series are suitable. One amplifier is sufficient but care should be taken regarding noise, dynamic range, etc.

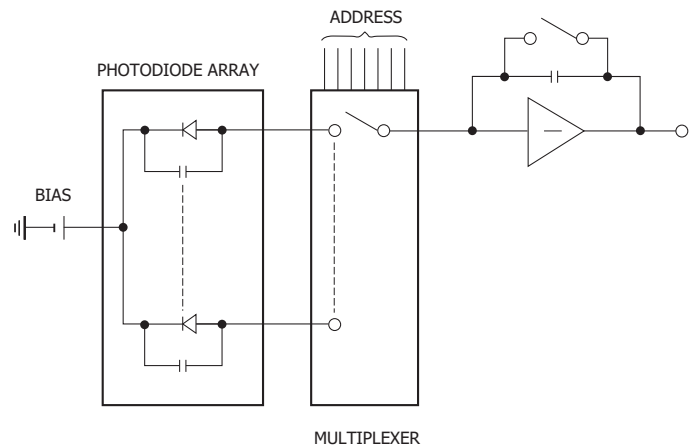

Hamamatsu also provides the C9004 driver circuit for Si photodiode arrays, that allows direct mounting of the S4111-16Q/R on the circuit board.

### ■ Precautions against UV light exposure

- When UV light irradiation is applied, the product characteristics may degrade. Such examples include degradation of the product's UV sensitivity and increase in dark current. This phenomenon varies depending on the irradiation level, irradiation intensity, usage time, and ambient environment and also varies depending on the product model. Before employing the product, we recommend that you check the tolerance under the ultraviolet light environment that the product will be used in.
- Exposure to UV light may cause the characteristics to degrade due to gas released from the resin bonding the product's component materials. As such, we recommend that you avoid applying UV light directly on the resin and apply it on only the inside of the photosensitive area by using an aperture or the like.

### ■ Related information

[www.hamamatsu.com/sp/ssd/doc\\_en.html](http://www.hamamatsu.com/sp/ssd/doc_en.html)

#### ■ Precautions

- Disclaimer
- Metal, ceramic, plastic package products

#### ■ Technical information

- Si photodiode/Application circuit examples

Information described in this material is current as of October, 2015.

Product specifications are subject to change without prior notice due to improvements or other reasons. This document has been carefully prepared and the information contained is believed to be accurate. In rare cases, however, there may be inaccuracies such as text errors. Before using these products, always contact us for the delivery specification sheet to check the latest specifications.

The product warranty is valid for one year after delivery and is limited to product repair or replacement for defects discovered and reported to us within that one year period. However, even if within the warranty period we accept absolutely no liability for any loss caused by natural disasters or improper product use. Copying or reprinting the contents described in this material in whole or in part is prohibited without our prior permission.

# HAMAMATSU

[www.hamamatsu.com](http://www.hamamatsu.com)

HAMAMATSU PHOTONICS K.K., Solid State Division

1126-1 Ichino-cho, Higashi-ku, Hamamatsu City, 435-8558 Japan, Telephone: (81) 53-434-3311, Fax: (81) 53-434-5184

U.S.A.: Hamamatsu Corporation: 360 Foothill Road, Bridgewater, N.J. 08807, U.S.A., Telephone: (1) 908-231-0960, Fax: (1) 908-231-1218

Germany: Hamamatsu Photonics Deutschland GmbH: Arzbergerstr. 10, D-82211 Herrsching am Ammersee, Germany, Telephone: (49) 8152-375-0, Fax: (49) 8152-265-8

France: Hamamatsu Photonics France S.A.R.L.: 19, Rue du Saule Trapu, Parc du Moulin de Massy, 91882 Massy Cedex, France, Telephone: 33-(1) 69 53 71 00, Fax: 33-(1) 69 53 71 10

United Kingdom: Hamamatsu Photonics UK Limited: 2 Howard Court, 10 Tewin Road, Welwyn Garden City, Hertfordshire AL7 1BW, United Kingdom, Telephone: (44) 1707-294888, Fax: (44) 1707-325777

North Europe: Hamamatsu Photonics Norden AB: Torshamnsgatan 35 16440 Kista, Sweden, Telephone: (46) 8-509-031-00, Fax: (46) 8-509-031-01

Italy: Hamamatsu Photonics Italia S.r.l.: Strada della Moia, 1 int. 6, 20020 Arese (Milano), Italy, Telephone: (39) 02-93581733, Fax: (39) 02-93581741

China: Hamamatsu Photonics (China) Co., Ltd.: B1201, Jiaming Center, No.27 Dongsanhuan Beilu, Chaoyang District, Beijing 100020, China, Telephone: (86) 10-6586-6006, Fax: (86) 10-6586-2866