

TOSHIBA CCD Linear Image Sensor CCD (Charge Coupled Device)

TCD1106GFG

TOSHIBA CCD Linear Image Sensor CCD (Charge Coupled Device)

TCD1106GFG

The TCD1106GFG is a high sensitive and low dark current 1500 elements linear image sensor.

Features

- Number of Image Sensing Elements: 1500 elements
- Image Sensing Element Size: 5.25 μm x 50 μm
- Photo Sensing Region: High sensitive and low dark current pn photodiode
- Function: Sample and hold circuit, CCD driving circuit, Timing generator circuit
- Power Supply: 3.3 V (typ.)
- Data Rate: 25 MHz (max)
- Package: 16 pin GLCC package

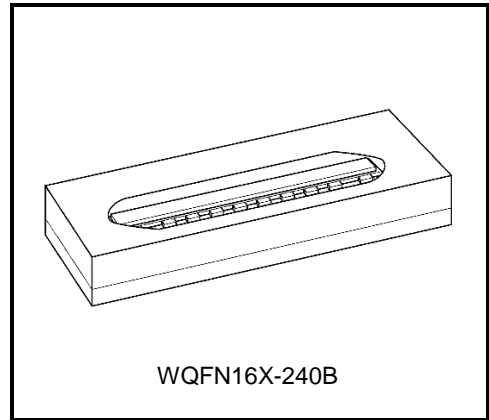

ABSOLUTE MAXIMUM RATINGS (Note 1)

Characteristics	Symbol	Rating	Unit
Master clock pulse voltage	V _{MCK}	-0.3 to +5.0	V
Shift pulse voltage	V _{SH}		
Digital power supply	V _{DD}		
Analog power supply	V _{AD}		
Operating temperature	T _{opr}	0 to 60	°C
Storage temperature	T _{stg}	-25 to +85	°C

Note 1: All voltage is with respect to GND terminals.

None of the ABSOLUTE MAXIMUM RATINGS must be exceeded, even instantaneously.

If any one of the ABSOLUTE MAXIMUM RATINGS is exceeded, the electrical characteristics, reliability and life time of the device cannot be guaranteed.

If the ABSOLUTE MAXIMUM RATINGS are exceeded, the device can be permanently damaged or degraded.

Create a system design in such a manner that any of the ABSOLUTE MAXIMUM RATINGS will not be exceeded under any circumstances.

Pin Connections (top view)

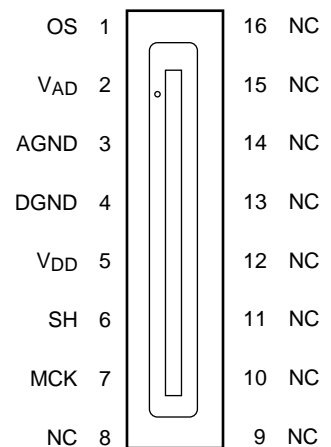

Block Diagram

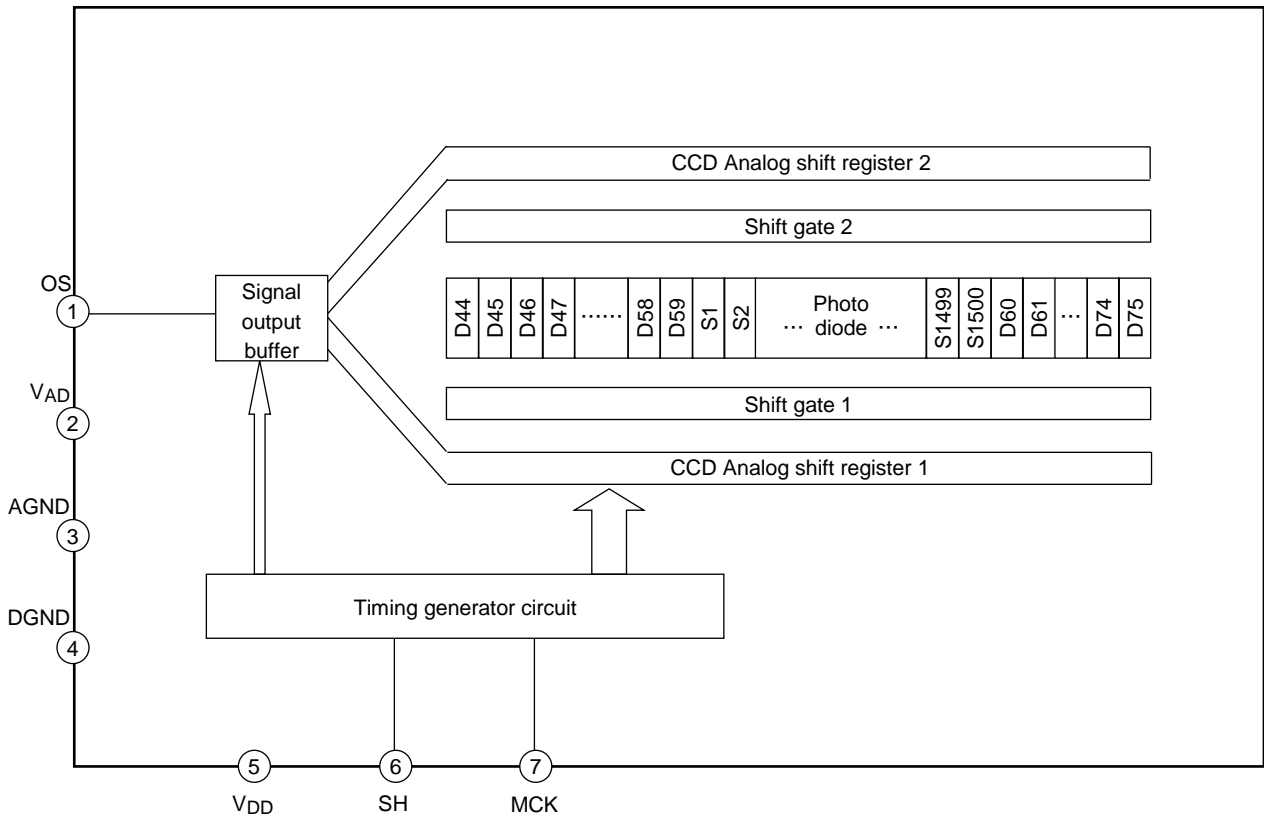

Pin Names

Pin No.	Symbol	Name	Pin No.	Symbol	Name
1	OS	Output signal	16	NC	Non connection
2	VAD	Power supply (Analog)	15	NC	Non connection
3	AGND	Ground (Analog)	14	NC	Non connection
4	DGND	Ground (Digital)	13	NC	Non connection
5	VDD	Power supply (Digital)	12	NC	Non connection
6	SH	Shift gate	11	NC	Non connection
7	MCK	Master clock	10	NC	Non connection
8	NC	Non connection	9	NC	Non connection

* All NC pins should be kept open, or connected to Ground on PCB.

Optical/Electrical Characteristics

Ta = 25 °C, VMCK = VSH = 3.3 V (Pulse), fMCK = 25 MHz, tINT(integration time) = 1 ms,

VDD = VAD = 3.3 V, Light source = A light source + CM500S (t = 1.0 mm)

Characteristics	Symbol	Min	Typ.	Max	Unit	Note
Sensitivity	R	—	(600)	—	V/(lx·s)	(Note2)
Photo response non uniformity	PRNU	—	—	(10)	%	(Note3)
Register imbalance	RI	—	(2)	(4)	%	(Note4)
Saturation output voltage	VSAT	(800)	—	—	mV	(Note5)
Saturation exposure	SE	(0.001)	—	—	lx·s	(Note6)
Dark signal voltage	VMDK	—	(2)	(5)	mV	(Note7)
DC power dissipation	PD	—	—	(90)	mW	
Total transfer efficiency	TTE	(92)	(95)	—	%	
Output impedance	Zo	—	(100)	—	Ω	
DC signal output voltage	VOS	—	(1200)	—	mV	(Note 8)
Dynamic range	DR	—	(400)	—	—	(Note 9)

() : Target value

Note 2: Sensitivity is defined for signal output when the photosensitive surface is applied with the light of uniform illumination and uniform color temperature.

Note 3: PRNU is defined for a single chip by the expressions below when the photosensitive surface is applied with the light of uniform illumination and uniform color temperature, where measured approximately 500 mV of signal output.

$$PRNU = \frac{\Delta X}{\bar{X}} \times 100 (\%)$$

\bar{X} : Average of total signal output

ΔX : The maximum deviation from \bar{X}

Note 4: Register imbalance is defined as follows.

$$RI = \frac{\sum_{n=1}^{1499} |X_n - X_{(n+1)}|}{1499 \times \bar{X}} \times 100 (\%)$$

\bar{X} : Average of total signal output

Note 5: VSAT is defined as the minimum saturation output of all effective pixels.

Note 6: Definition of SE

$$SE = \frac{VSAT}{R} (lx \cdot s)$$

Note 7: VMDK is defined as the maximum dark signal voltage of all effective pixels.

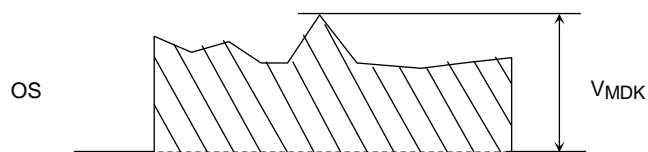

Note 8: DC signal output voltage is defined as follows.

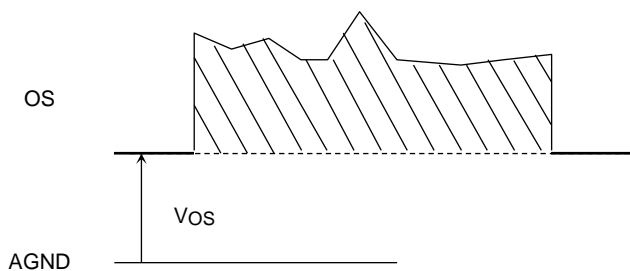

Note 9: Definition of DR

$$DR = \frac{VSAT}{VMDK}$$

VMDK is proportional to t_{INT} (Integration time), so the shorter t_{INT} condition makes wider DR.

Recommended Operating Conditions (Ta = 25 °C)

For best performance, the device should be used within the Recommended Operating Conditions.

Characteristics		Symbol	Min	Typ.	Max	Unit	Note
Master clock pulse voltage	"H" Level	VMCK	2.40	3.30	3.45	V	(Note 10)
	"L" Level		0	0	0.80		
Shift pulse voltage	"H" Level	VSH	2.40	3.30	3.45	V	(Note 10)
	"L" Level		0	0	0.80		
Power supply voltage (Digital)		VDD	3.15	3.30	3.45	V	(Note 11)
Power supply voltage (Analog)		VAD	3.15	3.30	3.45	V	(Note 11)

Note 10: MAX voltage of pulse voltage "H" Level = VDD = VAD

Note 11: VDD = VAD

Clock Characteristics (Ta = 25 °C)

For best performance, the device should be used within the Recommended Operating Conditions.

Characteristics	Symbol	Min	Typ.	Max	Unit
Master clock pulse frequency	fMCK	10	—	25	MHz
Data rate	fDATA	10	—	25	MHz
Master clock pin capacitance	CMCK	—	5	—	pF
Shift gate pin capacitance	CSH	—	5	—	pF

Timing Chart

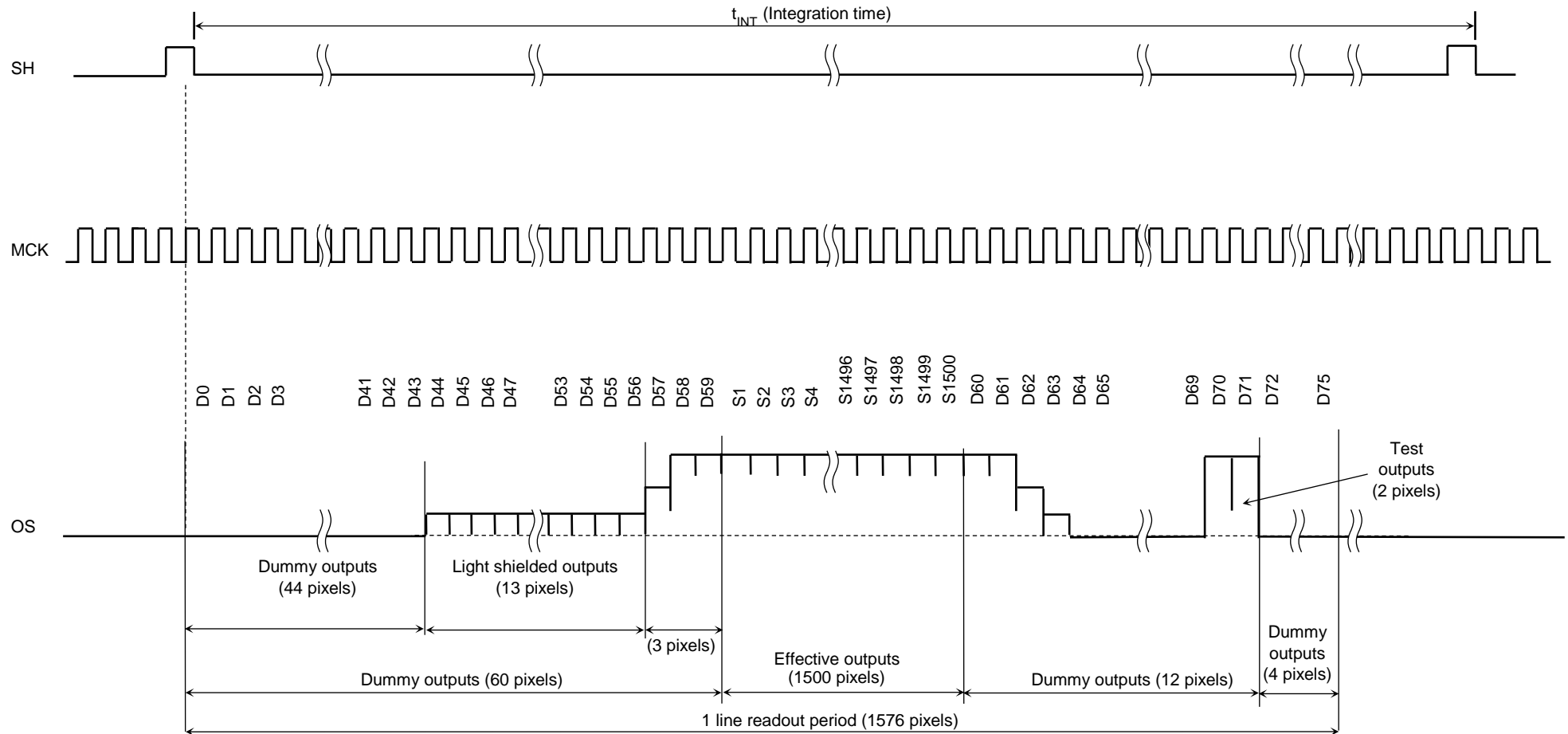

Timing Requirements

< SH, MCK, OS >

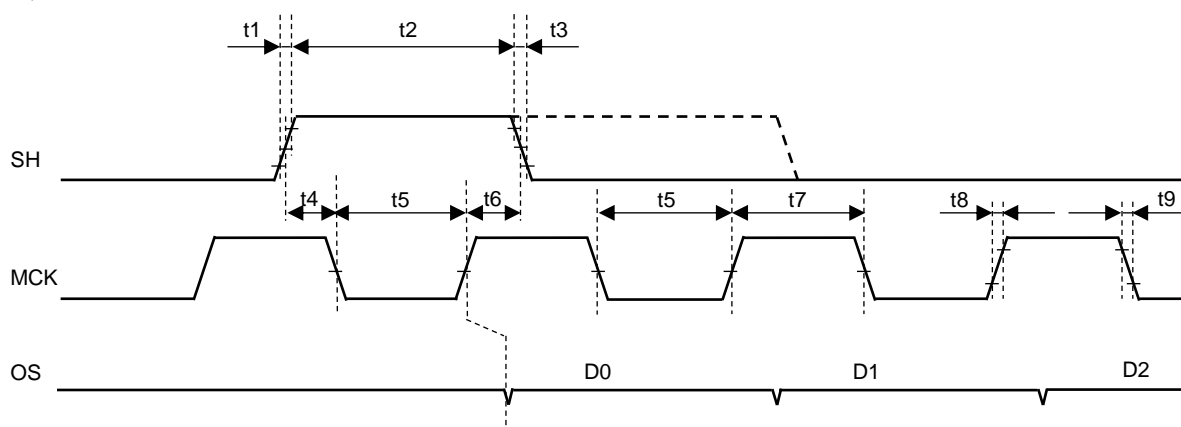

Characteristics	Symbol	Min	Typ.	Max	Unit
SH rise time	t1	—	—	3	ns
SH pulse width	t2	32	—	2MCK	ns
SH fall time	t3	—	—	3	ns
SH setup time	t4	6	—	—	ns
MCK pulse width	t5, t7	20	—	50	ns
SH hold time	t6	6	—	—	ns
MCK rise time	t8	—	—	3	ns
MCK fall time	t9	—	—	3	ns

Power sequencing specification

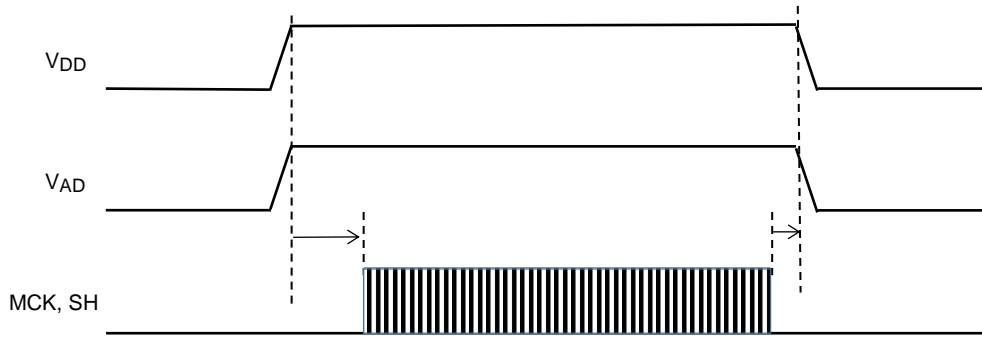

V_{DD} and V_{AD} should rise simultaneously.
 V_{DD} and V_{AD} should rise ahead of MCK and SH.
 When turn OFF power supply, set MCK and SH to low level first.

Typical spectral response (Reference only)

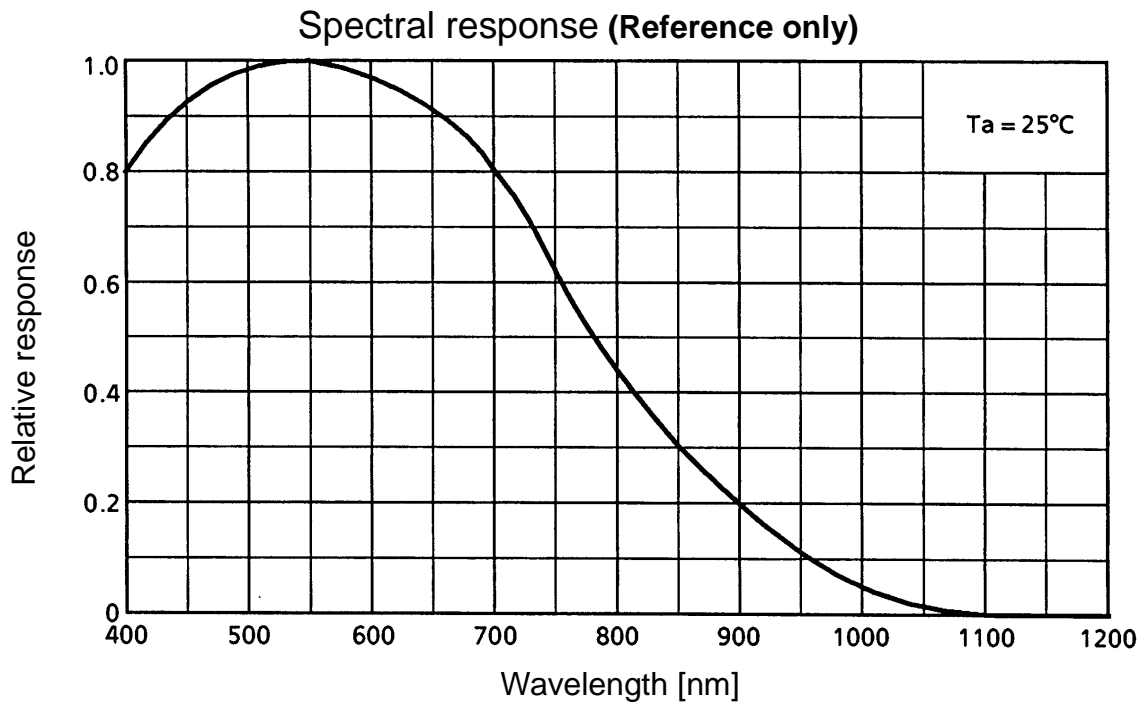

Typical Drive Circuit (Reference only)

* All NC pins should be kept open, or connected to Ground on PCB.
Connect VDD and VAD to a common power supply.

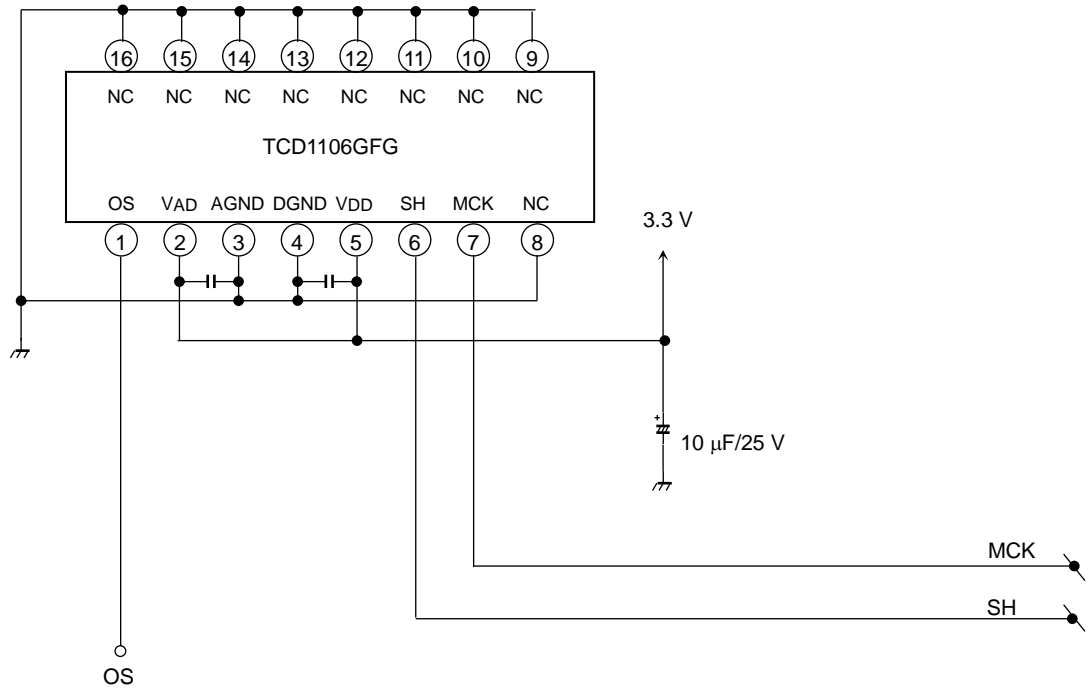

Caution

1. Electrostatic Breakdown

Store in shorting clip or in conductive foam to avoid electrostatic breakdown.

CCD Image Sensor is protected against static electricity, but inferior puncture mode device due to static electricity is sometimes detected. In handling the device, it is necessary to execute the following static electricity preventive measures, in order to prevent the trouble rate increase of the manufacturing system due to static electricity.

- a. Prevent the generation of static electricity due to friction by making the work with bare hands or by putting on cotton gloves and non-charging working clothes.
- b. Discharge the static electricity by providing earth plate or earth wire on the floor, door or stand of the work room.
- c. Ground the tools such as Soldering iron, cutting pliers, tweezers or pincer.
- d. When the product is handed, please use ground band to avoid the damage of CCD image sensor.
- e. Ionized air is recommended for discharge when handling CCD image sensors.

It is not necessarily required to execute all precaution items for static electricity.

It is all right to mitigate the precautions by confirming that the trouble rate within the prescribed range.

2. Incident Light

CCD sensor is sensitive to infrared light. Note that infrared light component degrades resolution and PRNU of CCD sensor.

Please do not expose to a strong light for a long time.

In the case of a color image sensor, if a strong light is applied for a long time, a color filter may fade.

3. Ultrasonic Cleaning

Ultrasonic cleaning should not be used with such hermetically-sealed ceramic package as CCD because the bonding wires can become disconnected due to resonance during the cleaning process.

4. Window Glass

The dust and stain on the glass window of the package degrade optical performance of CCD sensor.

Keep the glass window clean by saturating a cotton swab in alcohol and lightly wiping the surface, and allow the glass to dry, by blowing with filtered dry N₂. Care should be taken to avoid mechanical or thermal shock because the glass window is easily to damage.

5. Cleaning Method of the Window Glass Surface

Wiping Cloth

- a. Use soft cloth with a fine mesh.
- b. The wiping cloth must not cause dust from itself.
- c. Use a clean wiping cloth necessarily.

Cleaner

When using solvents, such as alcohol, unavoidably, it is cautious of the next.

- a. A clean thing with quick-drying.
- b. After liquid dries, there needs to be no residual substance.
- c. A thing safe for a human body.

And, please observe the use term of a solvent and use the storage container of a solvent to be clean.

Be cautious of fire enough.

Way of Cleaning

First, the surface of window glass is wiped with the wiping cloth into which the cleaner was infiltrated. Please wipe down the surface of window glass at least 2 times or more.

Next, the surface of window glass wipes with the dry wiping cloth. Please wipe down the surface of window glass at least 3 times or more.

Finally, blow cleaning is performed by dry N₂ filtered.

If operator wipes the surface of the window glass with the above-mentioned process and dirt still remains, TOSHIBA recommends repeating the clean operation from the beginning.

Be cautious of the next thing.

- a. Don't infiltrate the cleaner too much.
- b. A wiping portion is performed into the optical range and don't touch the edge of window glass.
- c. Be sure to wipe in a long direction and the same direction.
- d. A wiping cloth always uses an unused portion.

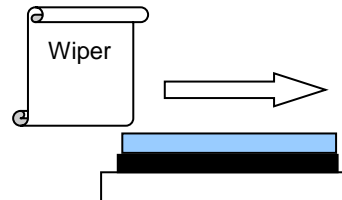

The standard reflow condition for GLCC (Surface Mount device)

1. Storage Precautions

- 1) Do not drop or toss device packaging. The laminated aluminum material in it can be rendered ineffective by rough handling.
- 2) Ensure devices should be stored in a 30 °C·90 %RH or better environment. Use devices within 12 months; do not store them longer than that.
- 3) In the following cases, in order to remove humidity from a device, bake for 24 hours at 125 °C. When a "30 % humidity indicator" has become pink after the package opened, or when the effective period of the indicator has passed.
- 4) Prevent destruction of the device by static electricity in the case of the bake processing for removing humidity.
- 5) After opening moisture-proof packing, store a product in 30 °C·60 %RH or better environment and use them within five days. If the effective usage period passed after opening the moisture-proof packing, baking should be done before use.
- 6) CCD surface mount products may have a haze on the inside of glass, so be careful about following. Even if the haze arises inside of glass, when it is not on the pixel area, there is no problem in quality.

2. Mounting Conditions Using Reflow

- 1) Mounting method:
 - (a) Hot air reflow
 - (b) Infrared ray reflow
- 2) Preheating condition: 150 to 180 °C, 60 to 120 s
- 3) Reflow condition:
 - (a) Maximum 240 °C
 - (b) Over 230 °C, within 30 to 50 s
- 4) Heating times: Only 1 time

* The temperature profile is specified in terms of the temperature of top surface of the device.
This temperature profile shows the maximum guaranteed device temperature. Please set up the optimum temperature profile conditions within the fig.1 profile.

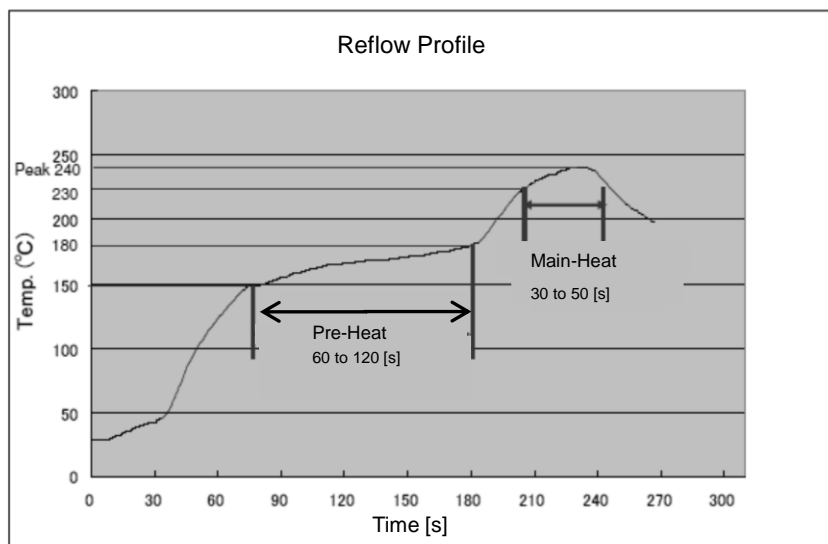

fig.1 Example of recommended temperature profile for reflows

In addition, in case of the repair work accompanied by IC removal, since the degree of parallel may be spoiled with the left solder, please do not carry out.

3. Mounting

- 1) In the case of solder mounting, the devices should be mounted with the window glass protective tape in order to avoid dust or dirt included in reflow machine.
- 2) The window glass protective tape is manufactured from materials in which static charges tend to build up. When removing the tape from CCD sensor after solder mounting, install an ionizer to prevent the tape from being charged with static electricity.
- 3) When the tape is removed, adhesives will remain in the glass surface. Since these adhesives appear as black or white flaws on the image, please wipe the window glass surface with the cloth into which the organic solvent was infiltrated. Then please attach CCD to a product.
- 4) Do not reuse the window glass protective tape.
- 5) The parts of glass seal area have possibility to be became clouded by reflow process, however, there is no problem in quality.

4. Foot Pattern on the PCB

We recommend fig.2's foot pattern for your PCB (Printed Circuit Board).

Unit: mm

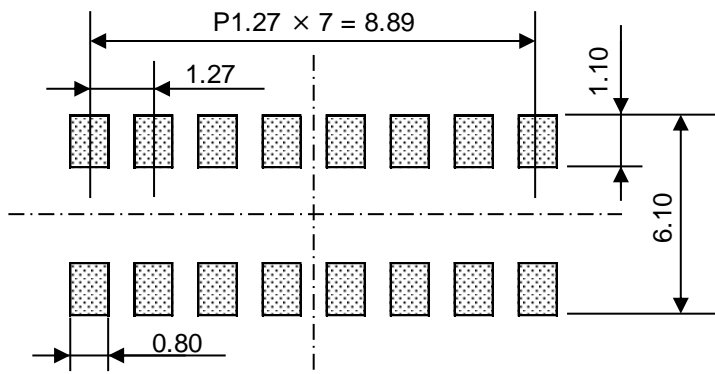

fig.2 Foot pattern

5. Mask for Solder Paste Application

We recommend metal mask that have the following thickness.

·Thickness: 0.1 mm.

And we recommend that the opened area size on the metal mask is 100 % for pads on solder.

Package Dimensions

WQFN16X-240B

Unit: mm

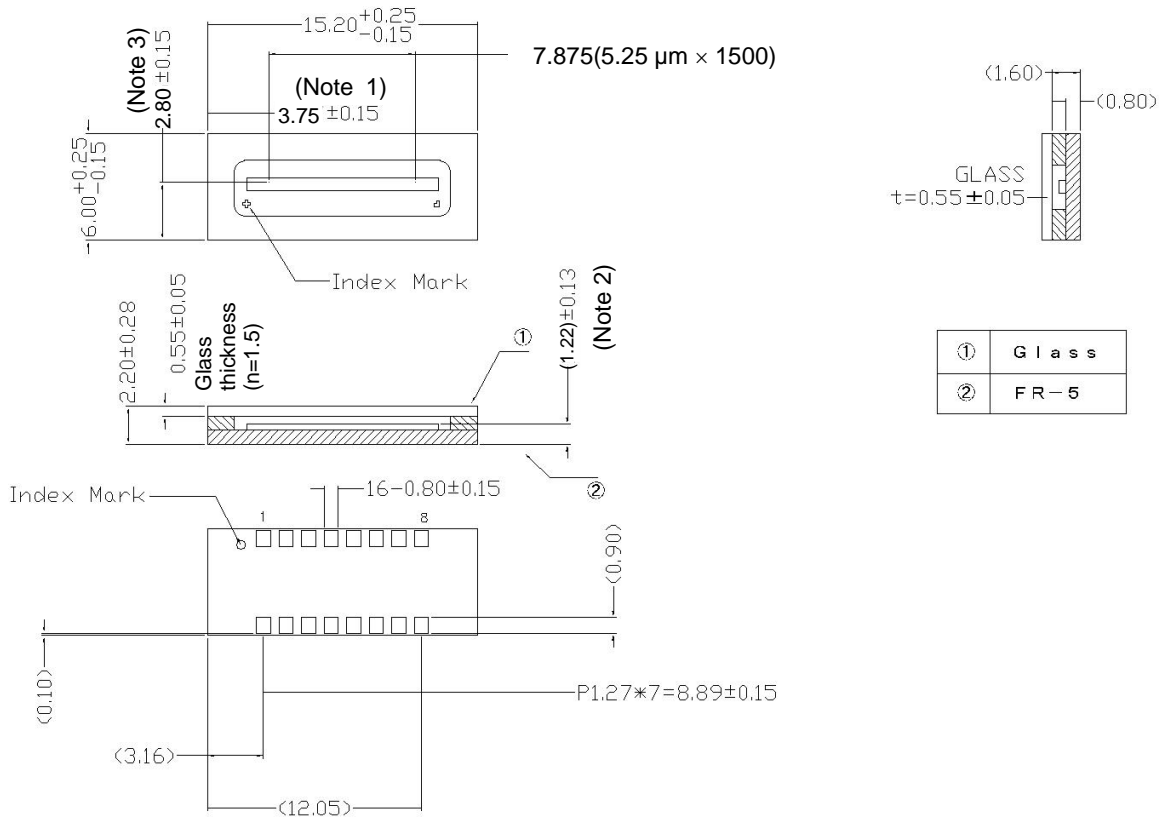

①	G l a s s
②	F R - 5

Note 1: Distance between the edge of the package and the first pixel (S1)

Note 2: Distance between the top of chip and bottom of the package

Note 3: Distance between the edge of the package and the chip center

RESTRICTIONS ON PRODUCT USE

Toshiba Corporation and its subsidiaries and affiliates are collectively referred to as "TOSHIBA". Hardware, software and systems described in this document are collectively referred to as "Product".

- TOSHIBA reserves the right to make changes to the information in this document and related Product without notice.
- This document and any information herein may not be reproduced without prior written permission from TOSHIBA. Even with TOSHIBA's written permission, reproduction is permissible only if reproduction is without alteration/omission.
- Though TOSHIBA works continually to improve Product's quality and reliability, Product can malfunction or fail. Customers are responsible for complying with safety standards and for providing adequate designs and safeguards for their hardware, software and systems which minimize risk and avoid situations in which a malfunction or failure of Product could cause loss of human life, bodily injury or damage to property, including data loss or corruption. Before customers use the Product, create designs including the Product, or incorporate the Product into their own applications, customers must also refer to and comply with (a) the latest versions of all relevant TOSHIBA information, including without limitation, this document, the specifications, the data sheets and application notes for Product and the precautions and conditions set forth in the "TOSHIBA Semiconductor Reliability Handbook" and (b) the instructions for the application with which the Product will be used with or for. Customers are solely responsible for all aspects of their own product design or applications, including but not limited to (a) determining the appropriateness of the use of this Product in such design or applications; (b) evaluating and determining the applicability of any information contained in this document, or in charts, diagrams, programs, algorithms, sample application circuits, or any other referenced documents; and (c) validating all operating parameters for such designs and applications. **TOSHIBA ASSUMES NO LIABILITY FOR CUSTOMERS' PRODUCT DESIGN OR APPLICATIONS.**
- **PRODUCT IS NEITHER INTENDED NOR WARRANTED FOR USE IN EQUIPMENTS OR SYSTEMS THAT REQUIRE EXTRAORDINARILY HIGH LEVELS OF QUALITY AND/OR RELIABILITY, AND/OR A MALFUNCTION OR FAILURE OF WHICH MAY CAUSE LOSS OF HUMAN LIFE, BODILY INJURY, SERIOUS PROPERTY DAMAGE AND/OR SERIOUS PUBLIC IMPACT ("UNINTENDED USE").** Except for specific applications as expressly stated in this document, Unintended Use includes, without limitation, equipment used in nuclear facilities, equipment used in the aerospace industry, lifesaving and/or life supporting medical equipment, equipment used for automobiles, trains, ships and other transportation, traffic signaling equipment, equipment used to control combustions or explosions, safety devices, elevators and escalators, and devices related to power plant. **IF YOU USE PRODUCT FOR UNINTENDED USE, TOSHIBA ASSUMES NO LIABILITY FOR PRODUCT.** For details, please contact your TOSHIBA sales representative or contact us via our website.
- Do not disassemble, analyze, reverse-engineer, alter, modify, translate or copy Product, whether in whole or in part.
- Product shall not be used for or incorporated into any products or systems whose manufacture, use, or sale is prohibited under any applicable laws or regulations.
- The information contained herein is presented only as guidance for Product use. No responsibility is assumed by TOSHIBA for any infringement of patents or any other intellectual property rights of third parties that may result from the use of Product. No license to any intellectual property right is granted by this document, whether express or implied, by estoppel or otherwise.
- **ABSENT A WRITTEN SIGNED AGREEMENT, EXCEPT AS PROVIDED IN THE RELEVANT TERMS AND CONDITIONS OF SALE FOR PRODUCT, AND TO THE MAXIMUM EXTENT ALLOWABLE BY LAW, TOSHIBA (1) ASSUMES NO LIABILITY WHATSOEVER, INCLUDING WITHOUT LIMITATION, INDIRECT, CONSEQUENTIAL, SPECIAL, OR INCIDENTAL DAMAGES OR LOSS, INCLUDING WITHOUT LIMITATION, LOSS OF PROFITS, LOSS OF OPPORTUNITIES, BUSINESS INTERRUPTION AND LOSS OF DATA, AND (2) DISCLAIMS ANY AND ALL EXPRESS OR IMPLIED WARRANTIES AND CONDITIONS RELATED TO SALE, USE OF PRODUCT, OR INFORMATION, INCLUDING WARRANTIES OR CONDITIONS OF MERCHANTABILITY, FITNESS FOR A PARTICULAR PURPOSE, ACCURACY OF INFORMATION, OR NONINFRINGEMENT.**
- Do not use or otherwise make available Product or related software or technology for any military purposes, including without limitation, for the design, development, use, stockpiling or manufacturing of nuclear, chemical, or biological weapons or missile technology products (mass destruction weapons). Product and related software and technology may be controlled under the applicable export laws and regulations including, without limitation, the Japanese Foreign Exchange and Foreign Trade Law and the U.S. Export Administration Regulations. Export and re-export of Product or related software or technology are strictly prohibited except in compliance with all applicable export laws and regulations.
- Please contact your TOSHIBA sales representative for details as to environmental matters such as the RoHS compatibility of Product. Please use Product in compliance with all applicable laws and regulations that regulate the inclusion or use of controlled substances, including without limitation, the EU RoHS Directive. **TOSHIBA ASSUMES NO LIABILITY FOR DAMAGES OR LOSSES OCCURRING AS A RESULT OF NONCOMPLIANCE WITH APPLICABLE LAWS AND REGULATIONS.**

TOSHIBA ELECTRONIC DEVICES & STORAGE CORPORATION

<https://toshiba.semicon-storage.com/>