

TPS763 低功耗 150mA 低压降线性稳压器

1 特性

- 150mA 低压降稳压器
- 输出电压：5V、3.8V、3.3V、3V、2.8V、2.7V、2.5V、1.8V、1.6V 以及可变电电压
- 150mA 时压降电压典型值为 300mV
- 过热保护
- 过流限制
- 关断模式下静态电流小于 2 μ A
- -40°C 至 125°C 的工作结温范围
- 5 引脚 SOT-23 (DBV) 封装

2 应用

- 电表
- 光伏逆变器
- HVAC 系统
- 伺服驱动器和运动控制
- 传感器变送器

TPS76350 负载瞬态响应

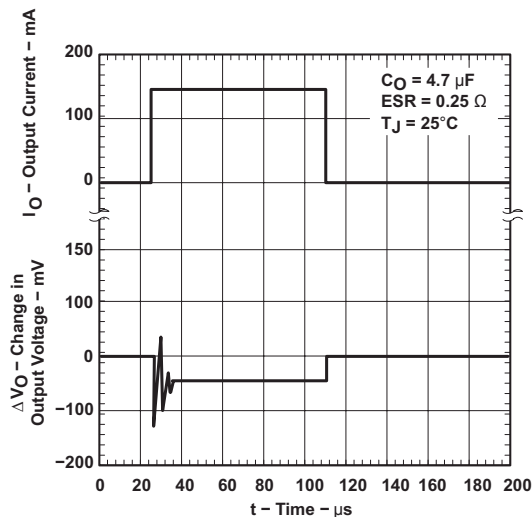

3 说明

TPS763xx 系列低压降 (LDO) 稳压器具有低压降电压、低功耗运行以及小型化封装等优点。与传统 LDO 稳压器相比，这些稳压器具有低压降电压和低静态电流。TPS763xx 系列器件采用 5 引脚、小外形集成电路 SOT-23 封装，非常适合成本敏感型设计和需要优先考虑布板空间的应用。

通过结合全新的电路设计和工艺创新，使用 PMOS 通道元件来替代普通的 PNP 通道晶体管。因为 PMOS 通道元件可用作低阻值电阻器，其压降电压较低（通常在 150mA 负载电流 (TPS76333) 下为 300mV），并且与负载电流成正比。因为 PMOS 通道元件是电压驱动型器件，其静态电流较低（最大值为 140 μ A），并且在整个输出负载电流范围（0mA 至 150mA）内可保持稳定。

该器件旨在用于笔记本电脑和手机等便携式系统，其低压降电压特性和低功耗运行可显著提高系统电池使用寿命。

TPS763xx 还支持使用逻辑睡眠模式关闭稳压器，从而可将 $T_J = 25^\circ\text{C}$ 时的静态电流最大值降至 1 μ A。

TPS763xx 具有 1.6V、1.8V、2.5V、2.7V、2.8V、3V、3.3V、3.8V 和 5V 固定电压版本和可变电电压版本（可在 1.5V 至 6.5V 范围内编程）。

器件信息⁽¹⁾

器件型号	封装	封装尺寸 (标称值)
TPS763xx	SOT-23 (5)	2.90mm × 1.60mm

(1) 如需了解所有可用封装，请参阅数据表末尾的可订购产品附录。



目录

1	特性	1	12.4	Device Functional Modes	12
2	应用	1	13	Application and Implementation	13
3	说明	1	13.1	Application Information	13
4	修订历史记录	2	13.2	Typical Application	13
5	Pin Configuration and Functions	3	14	Power Supply Recommendations	16
6	Specifications	3	14.1	Power Dissipation and Junction Temperature	16
7	Absolute Maximum Ratings	3	15	Layout	16
8	ESD Ratings	3	15.1	Layout Guidelines	16
9	Recommended Operating Conditions	3	15.2	Layout Example	16
10	Thermal Information	4	16	器件和文档支持	17
11	Electrical Characteristics	4	16.1	接收文档更新通知	17
11.1	Typical Characteristics	7	16.2	社区资源	17
12	Detailed Description	11	16.3	商标	17
12.1	Overview	11	16.4	静电放电警告	17
12.2	Functional Block Diagram	11	16.5	Glossary	17
12.3	Feature Description	11	17	机械、封装和可订购信息	17

4 修订历史记录

注：之前版本的页码可能与当前版本有所不同。

Changes from Revision I (December 2016) to Revision J

Page

•	Changed minimum specification from 4.75 V to 4.85 V in V_O parameter for TPS76350, $I_O = 1$ mA to 150 mA row in <i>Electrical Characteristics</i> table	5
---	--	---

Changes from Revision H (January 2004) to Revision I

Page

•	已添加 添加了 <i>ESD</i> 额定值表、特性说明部分、器件功能模式、应用和实施部分、电源相关建议部分、布局部分、器件和文档支持部分以及机械、封装和可订购信息部分	1
•	已删除 传统应用 和非陶瓷电容器已从应用 中删除	1
•	已添加 添加了电表、光伏逆变器、HVAC 系统、伺服器、运动控制以及传感器变送器，目标位置：应用	1
•	Deleted <i>Dissipation Ratings</i> table	3
•	Added <i>Thermal Information</i> table	4

5 Pin Configuration and Functions

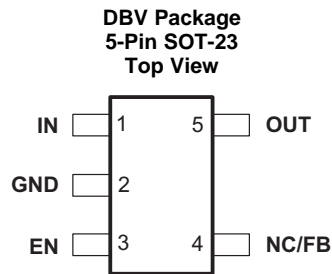

Pin Functions

PIN		I/O	DESCRIPTION
NO.	NAME		
1	IN	I	Input supply voltage
2	GND	—	Ground
3	EN	I	Enable input
4	NC/FB	—/I	No connection (fixed-voltage option only) or feedback voltage (TPS76301 only)
5	OUT	O	Regulated output voltage

6 Specifications

7 Absolute Maximum Ratings

over operating free-air temperature range (unless otherwise noted)⁽¹⁾

	MIN	MAX	UNIT
Input voltage	−0.3	10	V
Voltage at EN	−0.3	$V_I + 0.3$	V
Voltage on OUT, FB		7	V
Peak output current	Internally limited		
Operating junction temperature, T_J	−40	150	°C
Storage temperature, T_{stg}	−65	150	°C

- (1) Stresses beyond those listed under *Absolute Maximum Ratings* may cause permanent damage to the device. These are stress ratings only, which do not imply functional operation of the device at these or any other conditions beyond those indicated under *Recommended Operating Conditions*. Exposure to absolute-maximum-rated conditions for extended periods may affect device reliability.

8 ESD Ratings

			VALUE	UNIT
$V_{(ESD)}$	Electrostatic discharge	Human-body model (HBM), per ANSI/ESDA/JEDEC JS-001 ⁽¹⁾	±2000	V
		Charged-device model (CDM), per JEDEC specification JESD22-C101 ⁽²⁾	±250	

- (1) JEDEC document JEP155 states that 500-V HBM allows safe manufacturing with a standard ESD control process.
 (2) JEDEC document JEP157 states that 250-V CDM allows safe manufacturing with a standard ESD control process.

9 Recommended Operating Conditions

over operating free-air temperature range (unless otherwise noted)

		MIN	MAX	UNIT
V_I	Input voltage ⁽¹⁾	2.7	10	V
I_O	Continuous output current	0	150	mA
T_J	Operating junction temperature	−40	125	°C

- (1) To calculate the minimum input voltage for your maximum output current, use the following equation: $V_{I(min)} = V_{O(max)} + V_{DO(max\ load)}$

10 Thermal Information

THERMAL METRIC ⁽¹⁾		TPS763xx	UNIT
		DBV (SOT-23)	
		5 PINS	
$R_{\theta JA}$	Junction-to-ambient thermal resistance	205.3	°C/W
$R_{\theta JC(top)}$	Junction-to-case (top) thermal resistance	125.1	°C/W
$R_{\theta JB}$	Junction-to-board thermal resistance	34.6	°C/W
Ψ_{JT}	Junction-to-top characterization parameter	15.2	°C/W
Ψ_{JB}	Junction-to-board characterization parameter	33.8	°C/W
$R_{\theta JC(bot)}$	Junction-to-case (bottom) thermal resistance	—	°C/W

(1) For more information about traditional and new thermal metrics, see the [Semiconductor and IC Package Thermal Metrics](#) application report.

11 Electrical Characteristics

over recommended operating free-air temperature range, $V_I = V_{O(typ)} + 1\text{ V}$, $I_O = 1\text{ mA}$, $EN = IN$, and $C_O = 4.7\text{ }\mu\text{F}$ (unless otherwise noted)

PARAMETER		TEST CONDITIONS		MIN	TYP	MAX	UNIT
V_O	Output voltage	TPS76301	$3.25\text{ V} > V_I \geq 2.7\text{ V}$, $2.5\text{ V} \geq V_O \geq 1.5\text{ V}$, $I_O = 1\text{ mA to } 75\text{ mA}$, $T_J = 25^\circ\text{C}$	$0.98 \times V_O$	V_O	$1.02 \times V_O$	V
			$3.25\text{ V} > V_I \geq 2.7\text{ V}$, $2.5\text{ V} \geq V_O \geq 1.5\text{ V}$, $I_O = 1\text{ mA to } 75\text{ mA}$	$0.97 \times V_O$	V_O	$1.03 \times V_O$	
			$V_I \geq 3.25\text{ V}$, $5\text{ V} \geq V_O \geq 1.5\text{ V}$, $I_O = 1\text{ mA to } 100\text{ mA}$, $T_J = 25^\circ\text{C}$	$0.98 \times V_O$	V_O	$1.02 \times V_O$	
			$V_I \geq 3.25\text{ V}$, $5\text{ V} \geq V_O \geq 1.5\text{ V}$, $I_O = 1\text{ mA to } 100\text{ mA}$	$0.97 \times V_O$	V_O	$1.03 \times V_O$	
			$V_I \geq 3.25\text{ V}$, $5\text{ V} \geq V_O \geq 1.5\text{ V}$, $I_O = 1\text{ mA to } 150\text{ mA}$, $T_J = 25^\circ\text{C}$	$0.975 \times V_O$	V_O	$1.025 \times V_O$	
			$V_I \geq 3.25\text{ V}$, $5\text{ V} \geq V_O \geq 1.5\text{ V}$, $I_O = 1\text{ mA to } 150\text{ mA}$	$0.9625 \times V_O$	V_O	$1.0375 \times V_O$	
		TPS76316	$V_I = 2.7\text{ V}$, $1\text{ mA} < I_O < 75\text{ mA}$, $T_J = 25^\circ\text{C}$	1.568	1.6	1.632	
			$V_I = 2.7\text{ V}$, $1\text{ mA} < I_O < 75\text{ mA}$	1.552	1.6	1.648	
			$V_I = 3.25\text{ V}$, $1\text{ mA} < I_O < 100\text{ mA}$, $T_J = 25^\circ\text{C}$	1.568	1.6	1.632	
			$V_I = 3.25\text{ V}$, $1\text{ mA} < I_O < 100\text{ mA}$	1.552	1.6	1.648	
			$V_I = 3.25\text{ V}$, $1\text{ mA} < I_O < 150\text{ mA}$, $T_J = 25^\circ\text{C}$	1.56	1.6	1.64	
			$V_I = 3.25\text{ V}$, $1\text{ mA} < I_O < 150\text{ mA}$	1.536	1.6	1.664	
		TPS76318	$V_I = 2.7\text{ V}$, $1\text{ mA} < I_O < 75\text{ mA}$, $T_J = 25^\circ\text{C}$	1.764	1.8	1.836	
			$V_I = 2.7\text{ V}$, $1\text{ mA} < I_O < 75\text{ mA}$	1.746	1.8	1.854	
			$V_I = 3.25\text{ V}$, $1\text{ mA} < I_O < 100\text{ mA}$, $T_J = 25^\circ\text{C}$	1.764	1.8	1.836	
			$V_I = 3.25\text{ V}$, $1\text{ mA} < I_O < 100\text{ mA}$	1.746	1.8	1.854	
			$V_I = 3.25\text{ V}$, $1\text{ mA} < I_O < 150\text{ mA}$, $T_J = 25^\circ\text{C}$	1.755	1.8	1.845	
			$V_I = 3.25\text{ V}$, $1\text{ mA} < I_O < 150\text{ mA}$	1.733	1.8	1.867	

Electrical Characteristics (continued)

over recommended operating free-air temperature range, $V_I = V_{O(\text{typ})} + 1 \text{ V}$, $I_O = 1 \text{ mA}$, $EN = IN$, and $C_O = 4.7 \mu\text{F}$ (unless otherwise noted)

PARAMETER		TEST CONDITIONS	MIN	TYP	MAX	UNIT	
V_O	Output voltage (continued)	TPS76325	$I_O = 1 \text{ mA to } 100 \text{ mA}, T_J = 25^\circ\text{C}$	2.45	2.5	2.55	V
			$I_O = 1 \text{ mA to } 100 \text{ mA}$	2.425	2.5	2.575	
			$I_O = 1 \text{ mA to } 150 \text{ mA}, T_J = 25^\circ\text{C}$	2.438	2.5	2.562	
			$I_O = 1 \text{ mA to } 150 \text{ mA}$	2.407	2.5	2.593	
		TPS76327	$I_O = 1 \text{ mA to } 100 \text{ mA}, T_J = 25^\circ\text{C}$	2.646	2.7	2.754	
			$I_O = 1 \text{ mA to } 100 \text{ mA}$	2.619	2.7	2.781	
			$I_O = 1 \text{ mA to } 150 \text{ mA}, T_J = 25^\circ\text{C}$	2.632	2.7	2.767	
			$I_O = 1 \text{ mA to } 150 \text{ mA}$	2.599	2.7	2.801	
		TPS76328	$I_O = 1 \text{ mA to } 100 \text{ mA}, T_J = 25^\circ\text{C}$	2.744	2.8	2.856	
			$I_O = 1 \text{ mA to } 100 \text{ mA}$	2.716	2.8	2.884	
			$I_O = 1 \text{ mA to } 150 \text{ mA}, T_J = 25^\circ\text{C}$	2.73	2.8	2.87	
			$I_O = 1 \text{ mA to } 150 \text{ mA}$	2.695	2.8	2.905	
		TPS76330	$I_O = 1 \text{ mA to } 100 \text{ mA}, T_J = 25^\circ\text{C}$	2.94	3	3.06	
			$I_O = 1 \text{ mA to } 100 \text{ mA}$	2.91	3	3.09	
			$I_O = 1 \text{ mA to } 150 \text{ mA}, T_J = 25^\circ\text{C}$	2.925	3	3.075	
			$I_O = 1 \text{ mA to } 150 \text{ mA}$	2.888	3	3.112	
		TPS76333	$I_O = 1 \text{ mA to } 100 \text{ mA}, T_J = 25^\circ\text{C}$	3.234	3.3	3.366	
			$I_O = 1 \text{ mA to } 100 \text{ mA}$	3.201	3.3	3.399	
			$I_O = 1 \text{ mA to } 150 \text{ mA}, T_J = 25^\circ\text{C}$	3.218	3.3	3.382	
			$I_O = 1 \text{ mA to } 150 \text{ mA}$	3.177	3.3	3.423	
		TPS76338	$I_O = 1 \text{ mA to } 100 \text{ mA}, T_J = 25^\circ\text{C}$	3.724	3.8	3.876	
			$I_O = 1 \text{ mA to } 100 \text{ mA}$	3.705	3.8	3.895	
			$I_O = 1 \text{ mA to } 150 \text{ mA}, T_J = 25^\circ\text{C}$	3.686	3.8	3.914	
			$I_O = 1 \text{ mA to } 150 \text{ mA}$	3.667	3.8	3.933	
		TPS76350	$I_O = 1 \text{ mA to } 100 \text{ mA}, T_J = 25^\circ\text{C}$	4.875	5	5.125	
			$I_O = 1 \text{ mA to } 100 \text{ mA}$	4.825	5	5.175	
			$I_O = 1 \text{ mA to } 150 \text{ mA}, T_J = 25^\circ\text{C}$	4.85	5	5.15	
			$I_O = 1 \text{ mA to } 150 \text{ mA}$	4.8	5	5.2	
$I_{(Q)}$	Quiescent current (GND pin current)	$I_O = 1 \text{ mA to } 150 \text{ mA}, T_J = 25^\circ\text{C}^{(1)}$		85	100	μA	
		$I_O = 1 \text{ mA to } 150 \text{ mA}^{(2)}$			140		
	Standby current	$EN < 0.5 \text{ V}, T_J = 25^\circ\text{C}$		0.5	1	μA	
		$EN < 0.5 \text{ V}$			2		
V_n	Output noise voltage	$BW = 300 \text{ Hz to } 50 \text{ kHz}, T_J = 25^\circ\text{C}, C_O = 10 \mu\text{F}^{(2)}$		140		μV	
PSRR	Ripple rejection	$f = 1 \text{ kHz}, C_O = 10 \mu\text{F}, T_J = 25^\circ\text{C}^{(2)}$		60		dB	
	Current limit	$T_J = 25^\circ\text{C}^{(3)}$	0.5	0.8	1.5	A	
	Output voltage line regulation ($\Delta V_O/V_O$) ⁽³⁾	$V_O + 1 \text{ V} < V_I \leq 10 \text{ V}, V_I \geq 3.5 \text{ V}, T_J = 25^\circ\text{C}$		0.04%	0.07%	V	
		$V_O + 1 \text{ V} < V_I \leq 10 \text{ V}, V_I \geq 3.5 \text{ V}$			0.1%		
V_{IH}	EN high level input ⁽²⁾			1.4	2	V	
V_{IL}	EN low level input ⁽²⁾		0.5	1.2		V	

(1) Minimum I_N operating voltage is 2.7 V or $V_{O(\text{typ})} + 1 \text{ V}$, whichever is greater.

(2) Test conditions includes output voltage $V_O = 0 \text{ V}$ (for variable device FB is shorted to V_O), and pulse duration = 10 ms.

$$\text{Line Reg. (mV)} = (\% / \text{V}) \times \frac{V_O (V_{I\text{max}} - 3.5 \text{ V})}{100} \times 1000$$

(3) If $V_O < 2.5 \text{ V}$ and $V_{I\text{max}} = 10 \text{ V}$, $V_{I\text{min}} = 3.5 \text{ V}$:

$$\text{Line Reg. (mV)} = (\% / \text{V}) \times \frac{V_O (V_{I\text{max}} - (V_O + 1))}{100} \times 1000$$

If $V_O > 2.5 \text{ V}$ and $V_{I\text{max}} = 10 \text{ V}$, $V_{I\text{min}} = V_O + 1 \text{ V}$:

Electrical Characteristics (continued)

over recommended operating free-air temperature range, $V_I = V_{O(typ)} + 1\text{ V}$, $I_O = 1\text{ mA}$, $EN = IN$, and $C_O = 4.7\text{ }\mu\text{F}$ (unless otherwise noted)

PARAMETER		TEST CONDITIONS		MIN	TYP	MAX	UNIT
I_i	EN input current	EN = 0 V			-0.01	-0.5	μA
		EN = IN			-0.01	-0.5	
V_{DO}	Dropout voltage	TPS76325	$I_O = 0\text{ mA}$, $T_J = 25^\circ\text{C}$		0.2		mV
			$I_O = 1\text{ mA}$, $T_J = 25^\circ\text{C}$		3		
			$I_O = 50\text{ mA}$, $T_J = 25^\circ\text{C}$		120	150	
			$I_O = 50\text{ mA}$			200	
			$I_O = 75\text{ mA}$, $T_J = 25^\circ\text{C}$		180	225	
			$I_O = 75\text{ mA}$			300	
			$I_O = 100\text{ mA}$, $T_J = 25^\circ\text{C}$		240	300	
			$I_O = 100\text{ mA}$			400	
			$I_O = 150\text{ mA}$, $T_J = 25^\circ\text{C}$		360	450	
			$I_O = 150\text{ mA}$			600	
		TPS76333	$I_O = 0\text{ mA}$, $T_J = 25^\circ\text{C}$		0.2		
			$I_O = 1\text{ mA}$, $T_J = 25^\circ\text{C}$		3		
			$I_O = 50\text{ mA}$, $T_J = 25^\circ\text{C}$		100	125	
			$I_O = 50\text{ mA}$			166	
			$I_O = 75\text{ mA}$, $T_J = 25^\circ\text{C}$		150	188	
			$I_O = 75\text{ mA}$			250	
			$I_O = 100\text{ mA}$, $T_J = 25^\circ\text{C}$		200	250	
			$I_O = 100\text{ mA}$			333	
			$I_O = 150\text{ mA}$, $T_J = 25^\circ\text{C}$		300	375	
			$I_O = 150\text{ mA}$			500	
		TPS76350	$I_O = 0\text{ mA}$, $T_J = 25^\circ\text{C}$		0.2		
			$I_O = 1\text{ mA}$, $T_J = 25^\circ\text{C}$		2		
			$I_O = 50\text{ mA}$, $T_J = 25^\circ\text{C}$		60	75	
			$I_O = 50\text{ mA}$			100	
			$I_O = 75\text{ mA}$, $T_J = 25^\circ\text{C}$		90	113	
			$I_O = 75\text{ mA}$			150	
			$I_O = 100\text{ mA}$, $T_J = 25^\circ\text{C}$		120	150	
			$I_O = 100\text{ mA}$			200	
			$I_O = 150\text{ mA}$, $T_J = 25^\circ\text{C}$		180	225	
			$I_O = 150\text{ mA}$			300	

11.1 Typical Characteristics

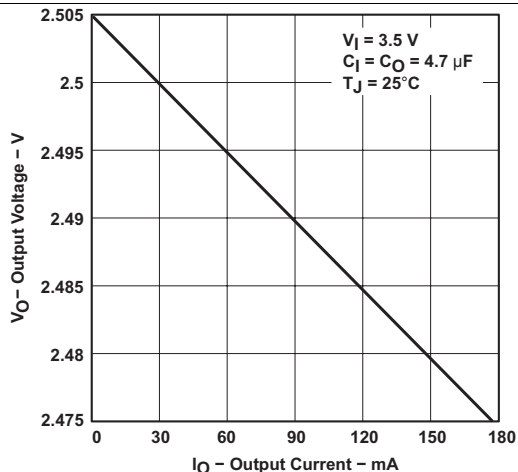

Figure 1. TPS76325 Output Voltage vs Output Current

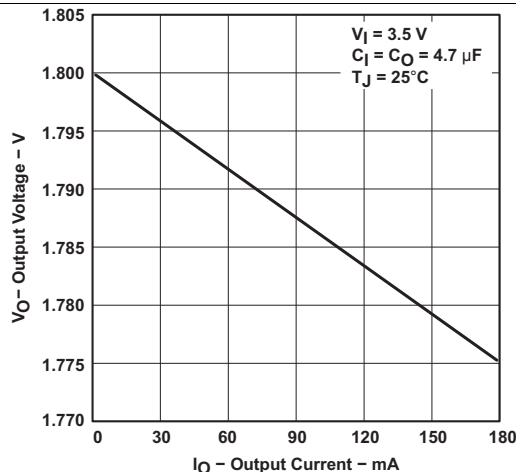

Figure 2. TPS76318 Output Voltage vs Output Current

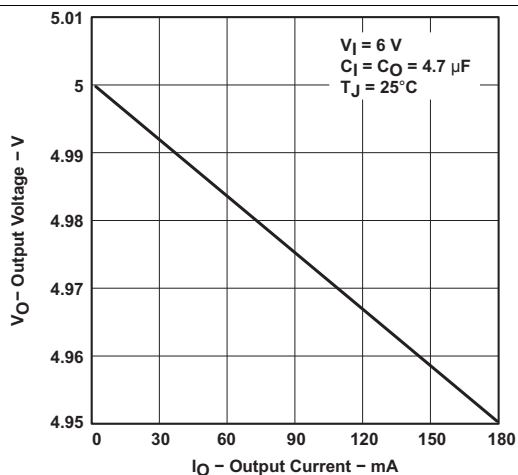

Figure 3. TPS76350 Output Voltage vs Output Current

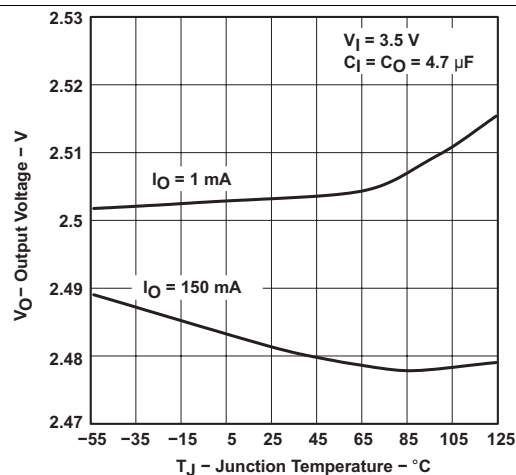

Figure 4. TPS76325 Output Voltage vs Output Current

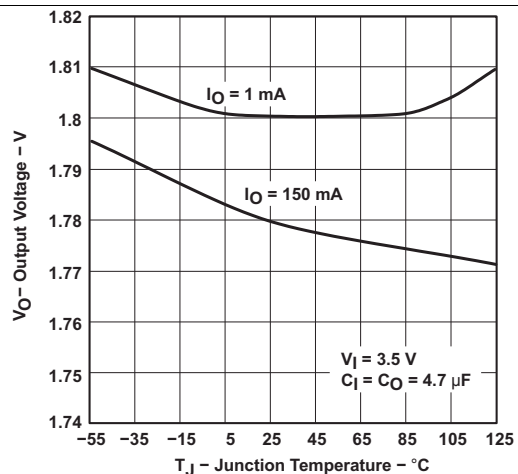

Figure 5. TPS76318 Output Voltage vs Free-Air Temperature

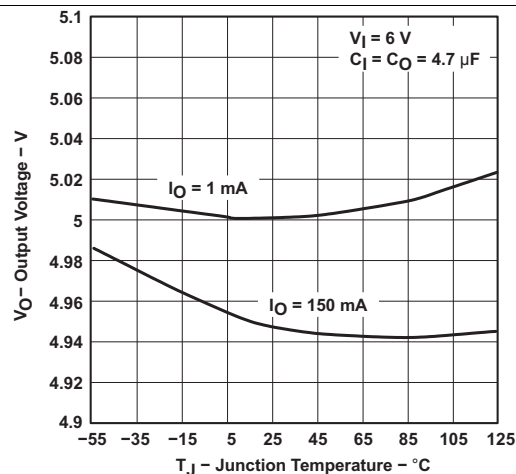
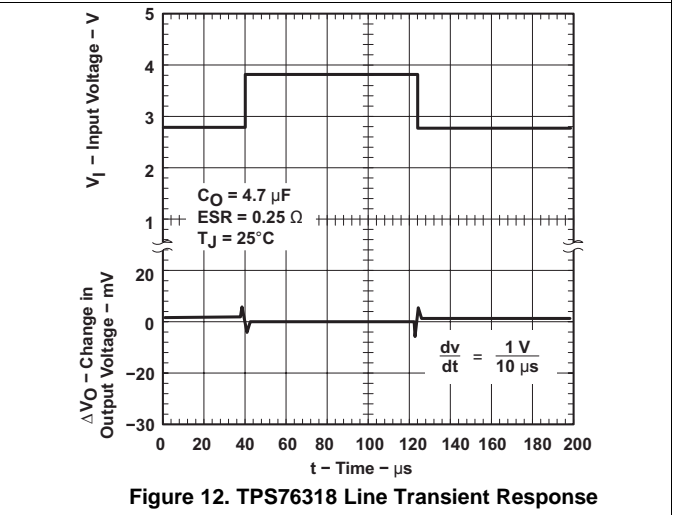
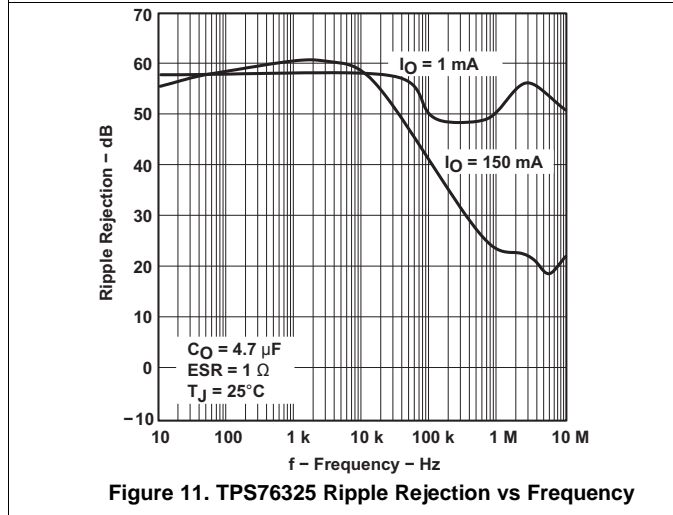
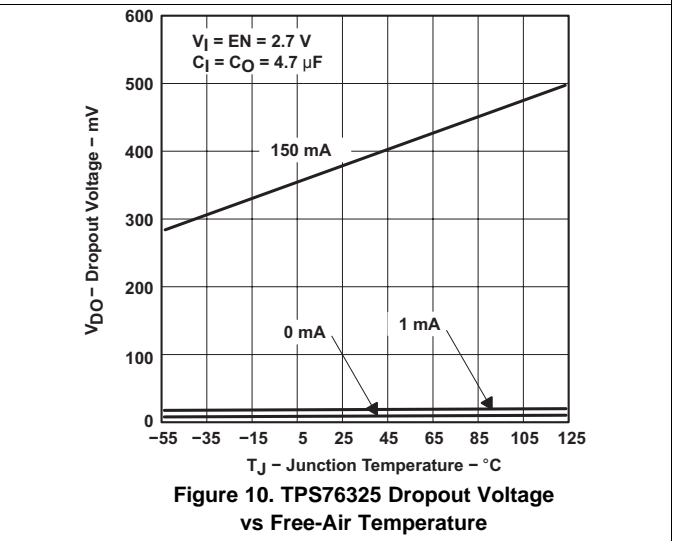
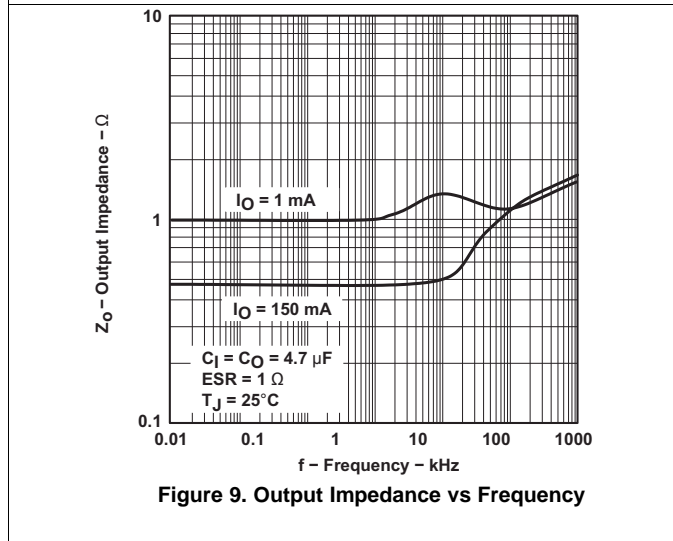
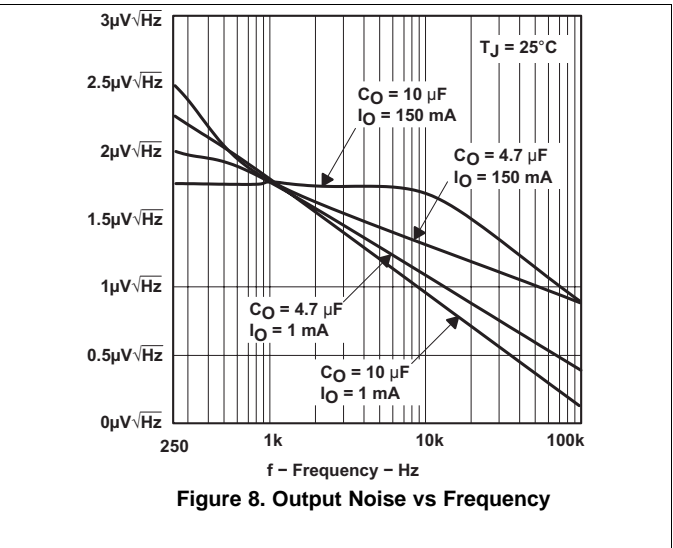
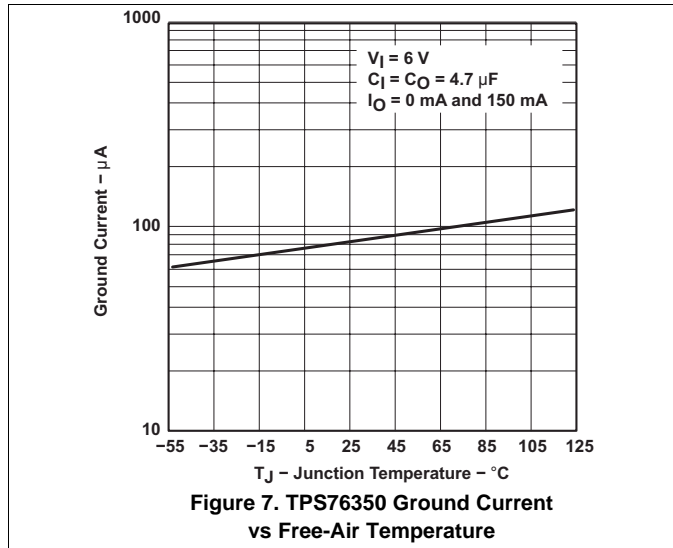

Figure 6. TPS76350 Output Voltage vs Free-Air Temperature

Typical Characteristics (continued)



Typical Characteristics (continued)

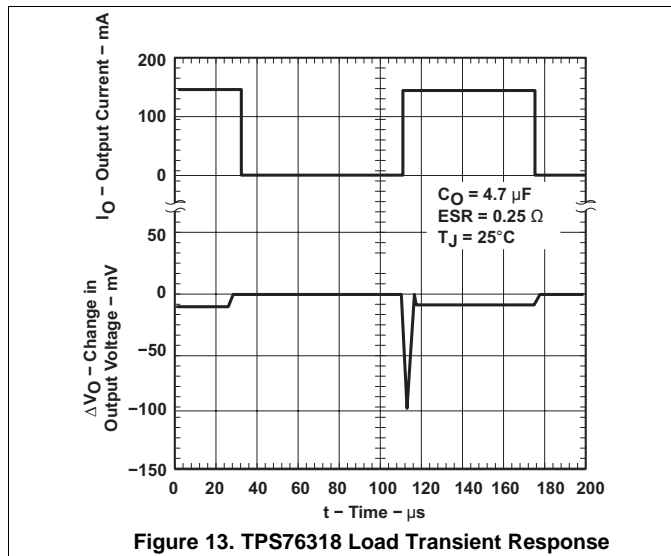

Figure 13. TPS76318 Load Transient Response

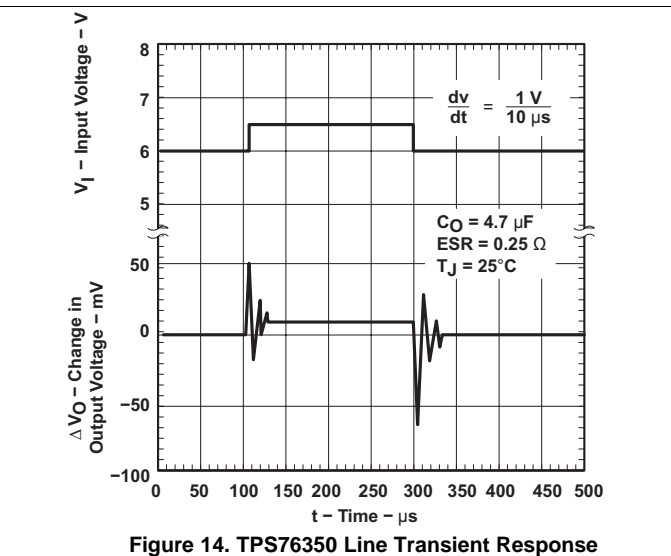

Figure 14. TPS76350 Line Transient Response

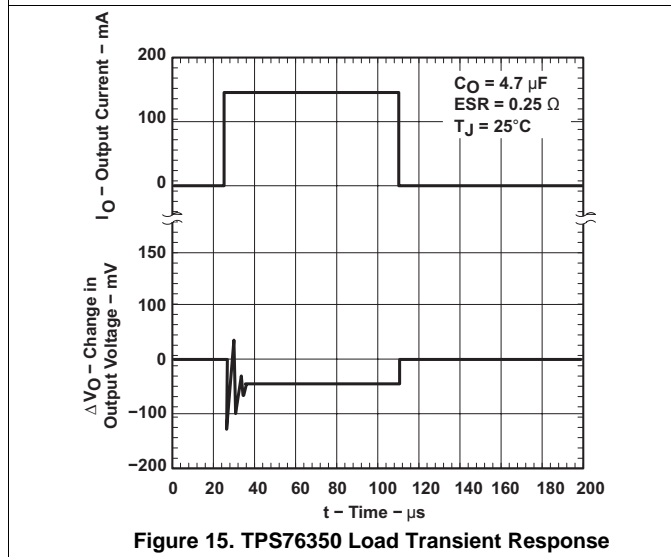

Figure 15. TPS76350 Load Transient Response

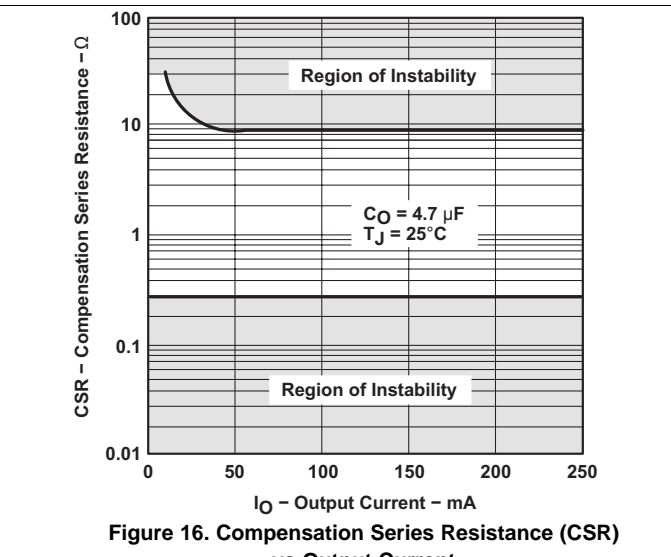

Figure 16. Compensation Series Resistance (CSR) vs Output Current

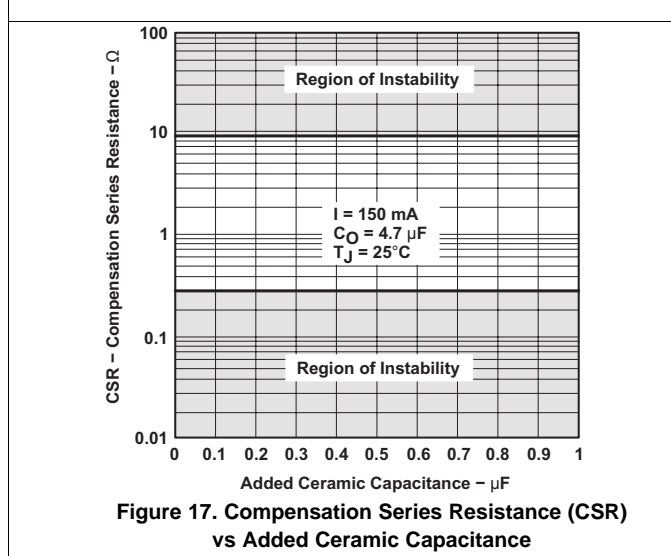

Figure 17. Compensation Series Resistance (CSR) vs Added Ceramic Capacitance

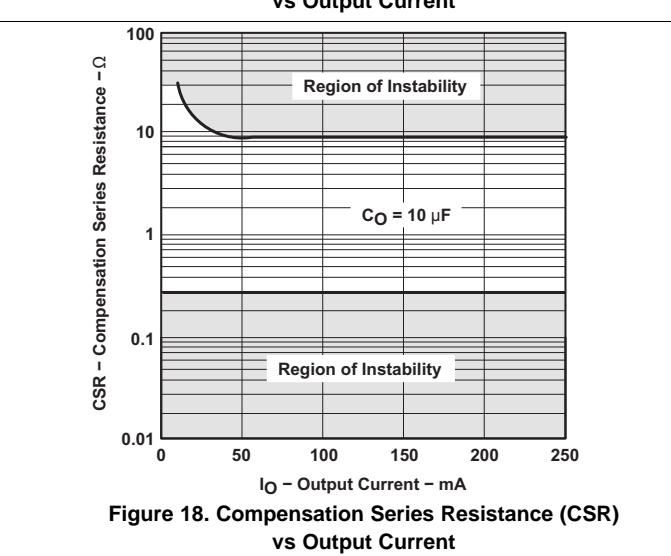

Figure 18. Compensation Series Resistance (CSR) vs Output Current

Typical Characteristics (continued)

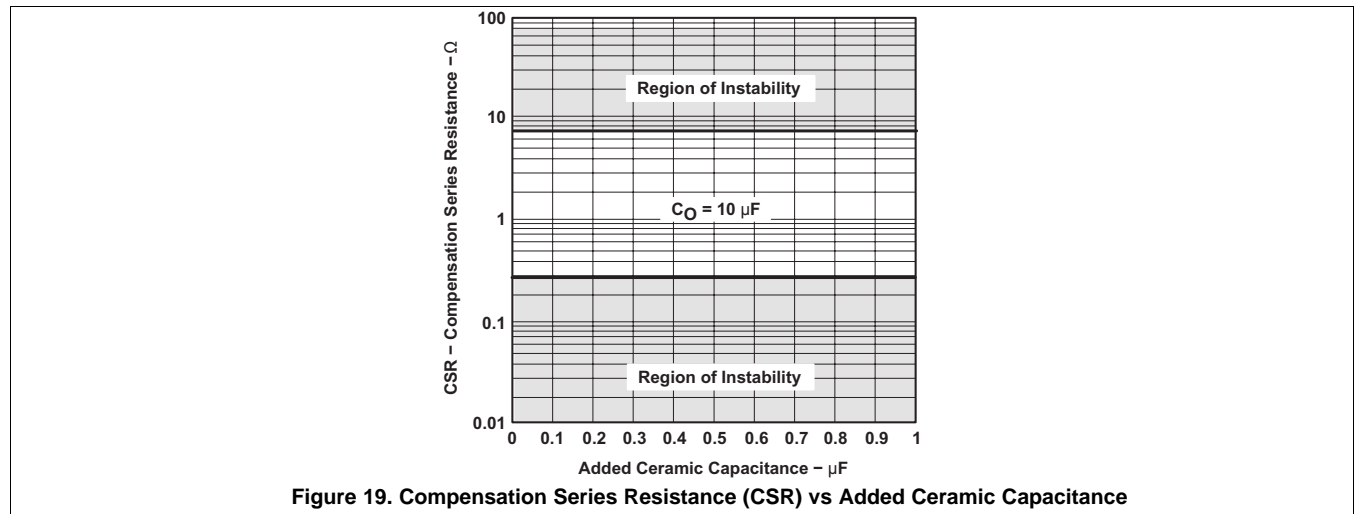

Figure 19. Compensation Series Resistance (CSR) vs Added Ceramic Capacitance

12 Detailed Description

12.1 Overview

The TPS763xx devices uses a PMOS pass element to dramatically reduce both dropout voltage and supply current over more conventional PNP pass element LDO designs. The PMOS pass element is a voltage-controlled device that, unlike a PNP transistor, does not require increased drive current as output current increases. Supply current in the TPS763xx is essentially constant from no-load to maximum load.

Current limiting and thermal protection prevent damage by excessive output current and/or power dissipation. The device switches into a constant-current mode at approximately 1 A; further load reduces the output voltage instead of increasing the output current. The thermal protection shuts the regulator off if the junction temperature rises above 165°C. Recovery is automatic when the junction temperature drops approximately 25°C below the high temperature trip point. The PMOS pass element includes a back diode that safely conducts reverse current when the input voltage level drops below the output voltage level.

A logic low on the enable input, EN shuts off the output and reduces the supply current to less than 2 μ A. EN must be tied high in applications where the shutdown feature is not used.

12.2 Functional Block Diagram

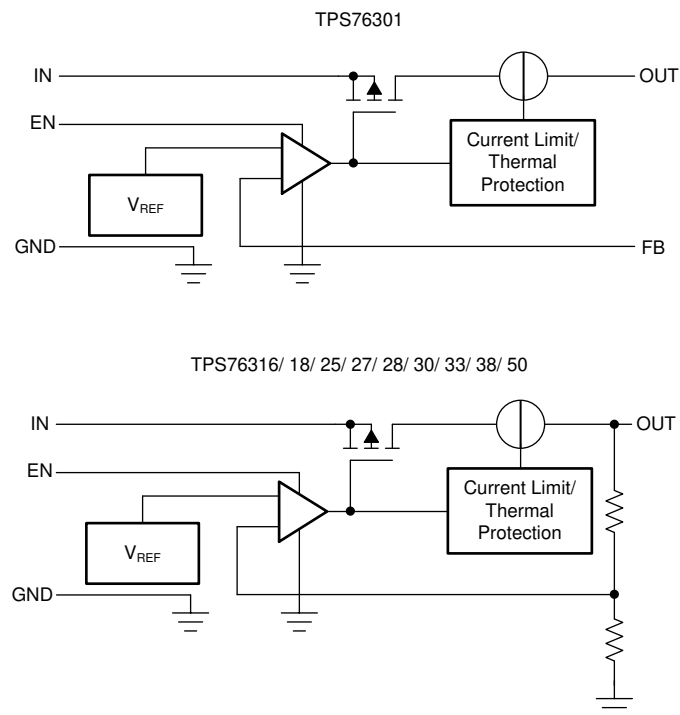

12.3 Feature Description

12.3.1 Regulator Protection

The TPS763xx features internal current limiting and thermal protection. During normal operation, the TPS763xx limits output current to approximately 800 mA. When current limiting engages, the output voltage scales back linearly until the overcurrent condition ends. While current limiting is designed to prevent gross device failure, take care not to exceed the power dissipation ratings of the package. If the temperature of the device exceeds 165°C, thermal-protection circuitry shuts it down. Once the device has cooled down to below 140°C, regulator operation resumes.

Feature Description (continued)

12.3.2 Enable

The enable signal (V_{EN}) is an active-high digital control that enables the LDO when the enable voltage is past the rising threshold ($V_{EN} \geq V_{IH(EN)}$) and disables the LDO when the enable voltage is below the falling threshold ($V_{EN} \leq V_{IL(EN)}$). The exact enable threshold is between $V_{IH(EN)}$ and $V_{IL(EN)}$ because EN is a digital control. In applications that do not use the enable control, connect EN to V_{IN} .

12.4 Device Functional Modes

Table 1 provides a quick comparison between the regulation and disabled operation.

Table 1. Device Functional Modes Comparison

OPERATING MODE	PARAMETER			
	V_{IN}	EN	I_{OUT}	T_J
Regulation ⁽¹⁾	$V_{IN} > V_{OUT(nom)} + V_{DO}$	$V_{EN} > V_{IH(EN)}$	$I_{OUT} < I_{CL}$	$T_J < T_{sd}$
Disabled ⁽²⁾	—	$V_{EN} < V_{IL(EN)}$	—	$T_J > T_{sd}$

(1) All table conditions must be met.

(2) The device is disabled when any condition is met.

12.4.1 Regulation

The device regulates the output to the targeted output voltage when all the conditions in Table 1 are met.

12.4.2 Disabled

When disabled, the pass device is turned off, the internal circuits are shutdown.

13 Application and Implementation

NOTE

Information in the following applications sections is not part of the TI component specification, and TI does not warrant its accuracy or completeness. TI's customers are responsible for determining suitability of components for their purposes. Customers should validate and test their design implementation to confirm system functionality.

13.1 Application Information

The TPS763xx low-dropout (LDO) regulators are part of a family of regulators which have been optimized for use in battery-operated equipment and feature extremely low dropout voltages, low quiescent current (140 μ A), and an enable input to reduce supply currents to less than 2 μ A when the regulator is turned off.

13.2 Typical Application

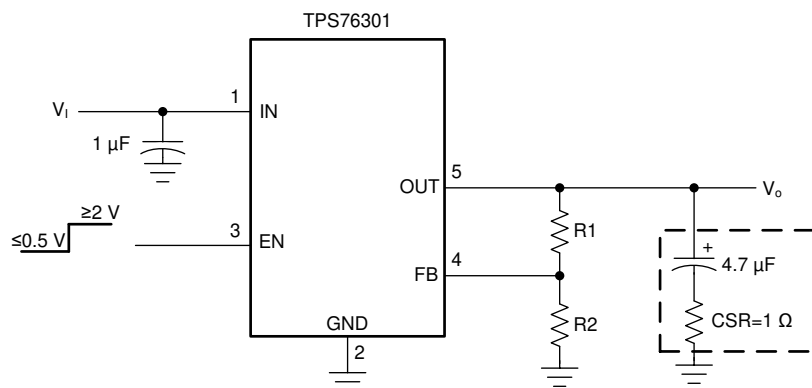

Figure 20. Typical Application Circuit

13.2.1 Design Requirements

Although not required, TI recommends a 0.047- μ F or larger ceramic bypass input capacitor, connected between IN and GND and placed close to the TPS763xx, to improve transient response and noise rejection. A higher-value electrolytic input capacitor may be necessary if large, fast-rise-time load transients are anticipated and the device is placed several inches from the power source. Follow the programming guidelines from [Table 2](#).

Table 2. Output Voltage Programming Guide

OUTPUT VOLTAGE (V)	DIVIDER RESISTANCE ($k\Omega$) ⁽¹⁾	
	R1	R2
2.5	187	169
3.3	301	169
3.6	348	169
4	402	169
5	549	169
6.45	750	169

(1) 1% values shown

13.2.2 Detailed Design Procedure

13.2.2.1 Capacitor Selection

Like all low dropout regulators, the TPS763xx requires an output capacitor connected between OUT and GND to stabilize the internal loop control. The minimum recommended capacitance value is 4.7 μF and the ESR (equivalent series resistance) must be between 0.3 Ω and 10 Ω. Capacitor values 4.7 μF or larger are acceptable, provided the ESR is less than 10 Ω. Solid tantalum electrolytic, aluminum electrolytic, and multilayer ceramic capacitors are all suitable, provided they meet the requirements described above. Most of the commercially available 4.7 μF surface-mount solid tantalum capacitors, including devices from Sprague, Kemet, and Nichico, meet the ESR requirements stated above (see Table 3).

Table 3. Capacitor Selection

PART NO.	MFR	VALUE	MAX ESR	SIZE (H x L x W)
T494B475K016AS	Kemet	4.7 μF	1.5 Ω	1.9 x 3.5 x 2.8
195D106x0016x2T	Sprague	10 μF	1.5 Ω	1.3 x 7 x 2.7
695D106x003562T	Sprague	10 μF	1.3 Ω	2.5 x 7.6 x 2.5
TPSC475K035R0600	AVX	4.7 μF	0.6 Ω	2.6 x 6 x 3.2

13.2.2.2 Output Voltage Programming

The output voltage of the TPS76301 adjustable regulator is programmed using an external resistor divider as shown in Figure 21. The output voltage is calculated using Equation 1.

$$V_O = 0.995 \times V_{ref} \times \left(1 + \frac{R1}{R2} \right)$$

where

- Vref = 1.192 V typical (the internal reference voltage)
 - 0.995 is a constant used to center the load regulator (1%)
- (1)

Resistors R1 and R2 must be chosen for approximately 7-μA divider current. Lower value resistors can be used but offer no inherent advantage and waste more power. Higher values must be avoided as leakage currents at FB increase the output voltage error. TI recommends choosing a design procedure of R2 = 169 kΩ to set the divider current at 7 μA and then calculate R1 using Equation 2.

$$R1 = \left(\frac{V_O}{0.995 \times V_{ref}} - 1 \right) \times R2$$

(2)

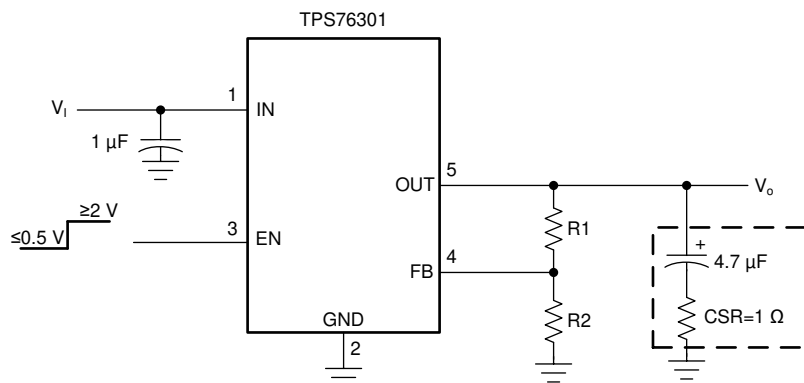
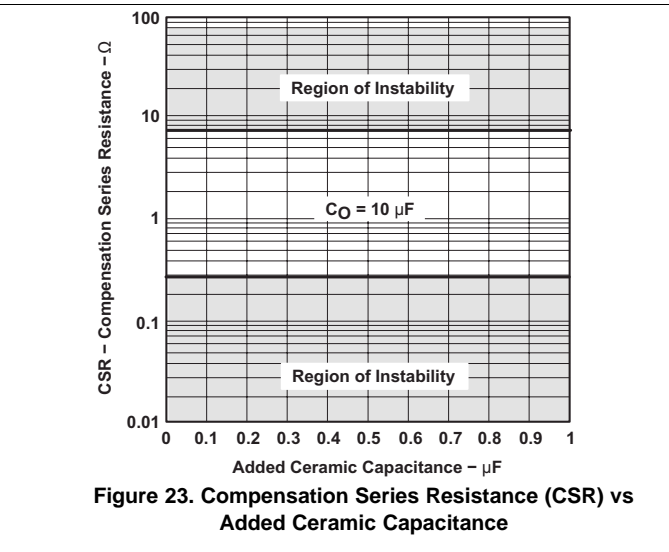
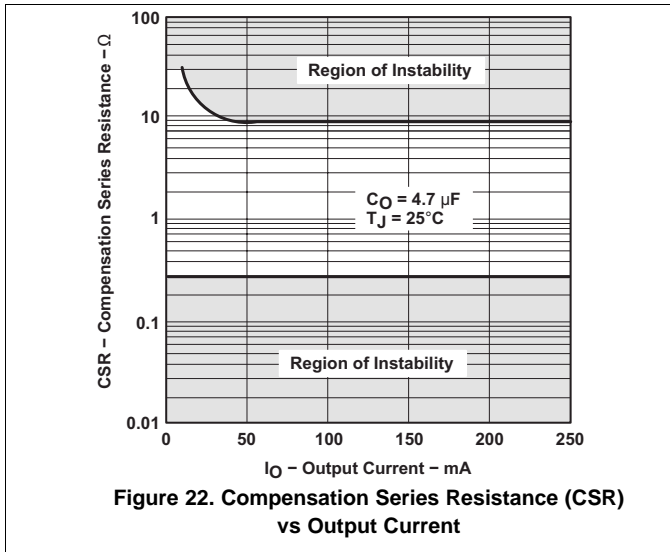

Figure 21. TPS76301 Adjustable LDO Regulator Programming

13.2.2.3 Reverse Current

The TPS763xx pass element has a built-in back diode that safely conducts reverse currents when the input voltage drops below the output voltage (for example, during power down). Current is conducted from the output to the input and is not internally limited. If extended reverse voltage is anticipated, external limiting might be appropriate.

13.2.3 Application Curves



14 Power Supply Recommendations

A 1- μ F or larger input capacitor must be used.

14.1 Power Dissipation and Junction Temperature

Specified regulator operation is assured to a junction temperature of 125°C; the maximum junction temperature allowable to avoid damaging the device is 150°C. This restriction limits the power dissipation the regulator can handle in any given application. To ensure the junction temperature is within acceptable limits, calculate the maximum allowable dissipation, $P_{D(max)}$, and the actual dissipation, P_D , which must be less than or equal to $P_{D(max)}$.

The maximum-power-dissipation limit is determined using [Equation 3](#).

$$P_{D(max)} = \frac{T_{Jmax} - T_A}{R_{\theta JA}}$$

where

- T_{Jmax} is the maximum allowable junction temperature
- $R_{\theta JA}$ is the thermal resistance junction-to-ambient for the package, see [Thermal Information](#)
- T_A is the ambient temperature

(3)

The regulator dissipation is calculating using [Equation 4](#).

$$P_D = (V_I - V_O) \times I_O$$

(4)

Power dissipation resulting from quiescent current is negligible.

15 Layout

15.1 Layout Guidelines

- Place input and output capacitors as close to the device as possible.
- Use copper planes for device connections to optimize thermal performance.
- Place thermal vias around the device to distribute the heat.

15.2 Layout Example

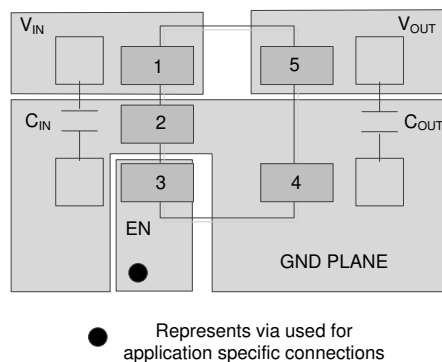

Figure 24. Layout Example for DBV Package

16 器件和文档支持

16.1 接收文档更新通知

要接收文档更新通知，请导航至 ti.com 上的器件产品文件夹。单击右上角的通知我进行注册，即可每周接收产品信息更改摘要。有关更改的详细信息，请查看任何已修订文档中包含的修订历史记录。

16.2 社区资源

TI E2E™ [support forums](#) are an engineer's go-to source for fast, verified answers and design help — straight from the experts. Search existing answers or ask your own question to get the quick design help you need.

Linked content is provided "AS IS" by the respective contributors. They do not constitute TI specifications and do not necessarily reflect TI's views; see TI's [Terms of Use](#).

16.3 商标

E2E is a trademark of Texas Instruments.

All other trademarks are the property of their respective owners.

16.4 静电放电警告



这些装置包含有限的内置 ESD 保护。存储或装卸时，应将导线一起截短或将装置放置于导电泡棉中，以防止 MOS 门极遭受静电损伤。

16.5 Glossary

[SLYZ022](#) — *TI Glossary*.

This glossary lists and explains terms, acronyms, and definitions.

17 机械、封装和可订购信息

以下页面包含机械、封装和可订购信息。这些信息是指定器件的最新可用数据。数据如有变更，恕不另行通知，且不会对此文档进行修订。如需获取此数据表的浏览器版本，请查阅左侧的导航栏。

PACKAGING INFORMATION

Orderable Device	Status (1)	Package Type	Package Drawing	Pins	Package Qty	Eco Plan (2)	Lead finish/ Ball material (6)	MSL Peak Temp (3)	Op Temp (°C)	Device Marking (4/5)	Samples
TPS76301DBVR	ACTIVE	SOT-23	DBV	5	3000	RoHS & Green	NIPDAU	Level-1-260C-UNLIM	-40 to 125	PAZI	Samples
TPS76301DBVRG4	ACTIVE	SOT-23	DBV	5	3000	RoHS & Green	NIPDAU	Level-1-260C-UNLIM	-40 to 125	PAZI	Samples
TPS76301DBVT	ACTIVE	SOT-23	DBV	5	250	RoHS & Green	NIPDAU	Level-1-260C-UNLIM	-40 to 125	PAZI	Samples
TPS76316DBVR	ACTIVE	SOT-23	DBV	5	3000	RoHS & Green	NIPDAU	Level-1-260C-UNLIM	-40 to 125	PBHI	Samples
TPS76316DBVRG4	ACTIVE	SOT-23	DBV	5	3000	RoHS & Green	NIPDAU	Level-1-260C-UNLIM	-40 to 125	PBHI	Samples
TPS76316DBVT	ACTIVE	SOT-23	DBV	5	250	RoHS & Green	NIPDAU	Level-1-260C-UNLIM	-40 to 125	PBHI	Samples
TPS76318DBVR	ACTIVE	SOT-23	DBV	5	3000	RoHS & Green	NIPDAU	Level-1-260C-UNLIM	-40 to 125	PBAI	Samples
TPS76318DBVRG4	ACTIVE	SOT-23	DBV	5	3000	RoHS & Green	NIPDAU	Level-1-260C-UNLIM	-40 to 125	PBAI	Samples
TPS76318DBVT	ACTIVE	SOT-23	DBV	5	250	RoHS & Green	NIPDAU	Level-1-260C-UNLIM	-40 to 125	PBAI	Samples
TPS76318DBVTG4	ACTIVE	SOT-23	DBV	5	250	RoHS & Green	NIPDAU	Level-1-260C-UNLIM	-40 to 125	PBAI	Samples
TPS76325DBVR	ACTIVE	SOT-23	DBV	5	3000	RoHS & Green	NIPDAU	Level-1-260C-UNLIM	-40 to 125	PBBI	Samples
TPS76325DBVRG4	ACTIVE	SOT-23	DBV	5	3000	RoHS & Green	NIPDAU	Level-1-260C-UNLIM	-40 to 125	PBBI	Samples
TPS76325DBVT	ACTIVE	SOT-23	DBV	5	250	RoHS & Green	NIPDAU	Level-1-260C-UNLIM	-40 to 125	PBBI	Samples
TPS76327DBVR	ACTIVE	SOT-23	DBV	5	3000	RoHS & Green	NIPDAU	Level-1-260C-UNLIM	-40 to 125	PBCI	Samples
TPS76327DBVT	ACTIVE	SOT-23	DBV	5	250	RoHS & Green	NIPDAU	Level-1-260C-UNLIM	-40 to 125	PBCI	Samples
TPS76327DBVTG4	ACTIVE	SOT-23	DBV	5	250	RoHS & Green	NIPDAU	Level-1-260C-UNLIM	-40 to 125	PBCI	Samples
TPS76328DBVR	ACTIVE	SOT-23	DBV	5	3000	RoHS & Green	NIPDAU	Level-1-260C-UNLIM	-40 to 125	PBDI	Samples
TPS76328DBVT	ACTIVE	SOT-23	DBV	5	250	RoHS & Green	NIPDAU	Level-1-260C-UNLIM	-40 to 125	PBDI	Samples
TPS76330DBVR	ACTIVE	SOT-23	DBV	5	3000	RoHS & Green	NIPDAU	Level-1-260C-UNLIM	-40 to 125	PBII	Samples
TPS76330DBVT	ACTIVE	SOT-23	DBV	5	250	RoHS & Green	NIPDAU	Level-1-260C-UNLIM	-40 to 125	PBII	Samples

Orderable Device	Status (1)	Package Type	Package Drawing	Pins	Package Qty	Eco Plan (2)	Lead finish/ Ball material (6)	MSL Peak Temp (3)	Op Temp (°C)	Device Marking (4/5)	Samples
TPS76333DBVR	ACTIVE	SOT-23	DBV	5	3000	RoHS & Green	NIPDAU	Level-1-260C-UNLIM	-40 to 125	PBEI	Samples
TPS76333DBVRG4	ACTIVE	SOT-23	DBV	5	3000	RoHS & Green	NIPDAU	Level-1-260C-UNLIM	-40 to 125	PBEI	Samples
TPS76333DBVT	ACTIVE	SOT-23	DBV	5	250	RoHS & Green	NIPDAU	Level-1-260C-UNLIM	-40 to 125	PBEI	Samples
TPS76333DBVTG4	ACTIVE	SOT-23	DBV	5	250	RoHS & Green	NIPDAU	Level-1-260C-UNLIM	-40 to 125	PBEI	Samples
TPS76338DBVR	ACTIVE	SOT-23	DBV	5	3000	RoHS & Green	NIPDAU	Level-1-260C-UNLIM	-40 to 125	PBFI	Samples
TPS76338DBVT	ACTIVE	SOT-23	DBV	5	250	RoHS & Green	NIPDAU	Level-1-260C-UNLIM	-40 to 125	PBFI	Samples
TPS76350DBVR	ACTIVE	SOT-23	DBV	5	3000	RoHS & Green	NIPDAU	Level-1-260C-UNLIM	-40 to 125	PBGI	Samples
TPS76350DBVRG4	ACTIVE	SOT-23	DBV	5	3000	RoHS & Green	NIPDAU	Level-1-260C-UNLIM	-40 to 125	PBGI	Samples
TPS76350DBVT	ACTIVE	SOT-23	DBV	5	250	RoHS & Green	NIPDAU	Level-1-260C-UNLIM	-40 to 125	PBGI	Samples
TPS76350DBVTG4	ACTIVE	SOT-23	DBV	5	250	RoHS & Green	NIPDAU	Level-1-260C-UNLIM	-40 to 125	PBGI	Samples

(1) The marketing status values are defined as follows:

ACTIVE: Product device recommended for new designs.

LIFEBUY: TI has announced that the device will be discontinued, and a lifetime-buy period is in effect.

NRND: Not recommended for new designs. Device is in production to support existing customers, but TI does not recommend using this part in a new design.

PREVIEW: Device has been announced but is not in production. Samples may or may not be available.

OBSOLETE: TI has discontinued the production of the device.

(2) **RoHS:** TI defines "RoHS" to mean semiconductor products that are compliant with the current EU RoHS requirements for all 10 RoHS substances, including the requirement that RoHS substance do not exceed 0.1% by weight in homogeneous materials. Where designed to be soldered at high temperatures, "RoHS" products are suitable for use in specified lead-free processes. TI may reference these types of products as "Pb-Free".

RoHS Exempt: TI defines "RoHS Exempt" to mean products that contain lead but are compliant with EU RoHS pursuant to a specific EU RoHS exemption.

Green: TI defines "Green" to mean the content of Chlorine (Cl) and Bromine (Br) based flame retardants meet JS709B low halogen requirements of <=1000ppm threshold. Antimony trioxide based flame retardants must also meet the <=1000ppm threshold requirement.

(3) MSL, Peak Temp. - The Moisture Sensitivity Level rating according to the JEDEC industry standard classifications, and peak solder temperature.

(4) There may be additional marking, which relates to the logo, the lot trace code information, or the environmental category on the device.

(5) Multiple Device Markings will be inside parentheses. Only one Device Marking contained in parentheses and separated by a "-" will appear on a device. If a line is indented then it is a continuation of the previous line and the two combined represent the entire Device Marking for that device.

(6) Lead finish/Ball material - Orderable Devices may have multiple material finish options. Finish options are separated by a vertical ruled line. Lead finish/Ball material values may wrap to two lines if the finish value exceeds the maximum column width.

Important Information and Disclaimer:The information provided on this page represents TI's knowledge and belief as of the date that it is provided. TI bases its knowledge and belief on information provided by third parties, and makes no representation or warranty as to the accuracy of such information. Efforts are underway to better integrate information from third parties. TI has taken and continues to take reasonable steps to provide representative and accurate information but may not have conducted destructive testing or chemical analysis on incoming materials and chemicals. TI and TI suppliers consider certain information to be proprietary, and thus CAS numbers and other limited information may not be available for release.

In no event shall TI's liability arising out of such information exceed the total purchase price of the TI part(s) at issue in this document sold by TI to Customer on an annual basis.

OTHER QUALIFIED VERSIONS OF TPS763 :

- Automotive : [TPS763-Q1](#)

NOTE: Qualified Version Definitions:

- Automotive - Q100 devices qualified for high-reliability automotive applications targeting zero defects

TAPE AND REEL INFORMATION



QUADRANT ASSIGNMENTS FOR PIN 1 ORIENTATION IN TAPE



*All dimensions are nominal

Device	Package Type	Package Drawing	Pins	SPQ	Reel Diameter (mm)	Reel Width W1 (mm)	A0 (mm)	B0 (mm)	K0 (mm)	P1 (mm)	W (mm)	Pin1 Quadrant
TPS76301DBVR	SOT-23	DBV	5	3000	179.0	8.4	3.2	3.2	1.4	4.0	8.0	Q3
TPS76301DBVR	SOT-23	DBV	5	3000	178.0	9.0	3.23	3.17	1.37	4.0	8.0	Q3
TPS76301DBVT	SOT-23	DBV	5	250	179.0	8.4	3.2	3.2	1.4	4.0	8.0	Q3
TPS76301DBVT	SOT-23	DBV	5	250	178.0	9.0	3.23	3.17	1.37	4.0	8.0	Q3
TPS76316DBVR	SOT-23	DBV	5	3000	178.0	9.0	3.23	3.17	1.37	4.0	8.0	Q3
TPS76316DBVT	SOT-23	DBV	5	250	178.0	9.0	3.23	3.17	1.37	4.0	8.0	Q3
TPS76318DBVR	SOT-23	DBV	5	3000	179.0	8.4	3.2	3.2	1.4	4.0	8.0	Q3
TPS76318DBVR	SOT-23	DBV	5	3000	178.0	9.0	3.3	3.2	1.4	4.0	8.0	Q3
TPS76318DBVT	SOT-23	DBV	5	250	178.0	9.0	3.23	3.17	1.37	4.0	8.0	Q3
TPS76318DBVT	SOT-23	DBV	5	250	179.0	8.4	3.2	3.2	1.4	4.0	8.0	Q3
TPS76325DBVR	SOT-23	DBV	5	3000	178.0	9.0	3.23	3.17	1.37	4.0	8.0	Q3
TPS76325DBVT	SOT-23	DBV	5	250	178.0	9.0	3.23	3.17	1.37	4.0	8.0	Q3
TPS76327DBVR	SOT-23	DBV	5	3000	178.0	9.0	3.23	3.17	1.37	4.0	8.0	Q3
TPS76327DBVT	SOT-23	DBV	5	250	178.0	9.0	3.23	3.17	1.37	4.0	8.0	Q3
TPS76328DBVR	SOT-23	DBV	5	3000	178.0	9.0	3.23	3.17	1.37	4.0	8.0	Q3
TPS76328DBVT	SOT-23	DBV	5	250	178.0	9.0	3.23	3.17	1.37	4.0	8.0	Q3
TPS76330DBVR	SOT-23	DBV	5	3000	178.0	9.0	3.23	3.17	1.37	4.0	8.0	Q3
TPS76330DBVT	SOT-23	DBV	5	250	178.0	9.0	3.23	3.17	1.37	4.0	8.0	Q3

Device	Package Type	Package Drawing	Pins	SPQ	Reel Diameter (mm)	Reel Width W1 (mm)	A0 (mm)	B0 (mm)	K0 (mm)	P1 (mm)	W (mm)	Pin1 Quadrant
TPS76333DBVR	SOT-23	DBV	5	3000	179.0	8.4	3.2	3.2	1.4	4.0	8.0	Q3
TPS76333DBVR	SOT-23	DBV	5	3000	178.0	9.0	3.23	3.17	1.37	4.0	8.0	Q3
TPS76333DBVT	SOT-23	DBV	5	250	178.0	9.0	3.23	3.17	1.37	4.0	8.0	Q3
TPS76333DBVT	SOT-23	DBV	5	250	179.0	8.4	3.2	3.2	1.4	4.0	8.0	Q3
TPS76338DBVR	SOT-23	DBV	5	3000	178.0	9.0	3.23	3.17	1.37	4.0	8.0	Q3
TPS76338DBVT	SOT-23	DBV	5	250	178.0	9.0	3.23	3.17	1.37	4.0	8.0	Q3
TPS76350DBVR	SOT-23	DBV	5	3000	178.0	9.0	3.23	3.17	1.37	4.0	8.0	Q3
TPS76350DBVT	SOT-23	DBV	5	250	178.0	9.0	3.3	3.2	1.4	4.0	8.0	Q3

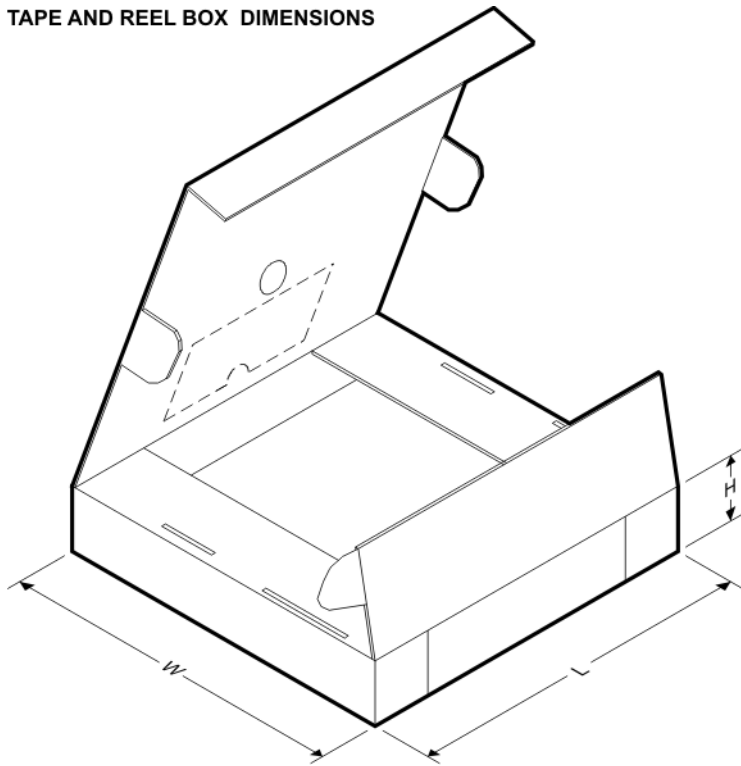
TAPE AND REEL BOX DIMENSIONS

*All dimensions are nominal

Device	Package Type	Package Drawing	Pins	SPQ	Length (mm)	Width (mm)	Height (mm)
TPS76301DBVR	SOT-23	DBV	5	3000	200.0	183.0	25.0
TPS76301DBVR	SOT-23	DBV	5	3000	180.0	180.0	18.0
TPS76301DBVT	SOT-23	DBV	5	250	200.0	183.0	25.0
TPS76301DBVT	SOT-23	DBV	5	250	180.0	180.0	18.0
TPS76316DBVR	SOT-23	DBV	5	3000	180.0	180.0	18.0
TPS76316DBVT	SOT-23	DBV	5	250	180.0	180.0	18.0
TPS76318DBVR	SOT-23	DBV	5	3000	200.0	183.0	25.0
TPS76318DBVR	SOT-23	DBV	5	3000	180.0	180.0	18.0
TPS76318DBVT	SOT-23	DBV	5	250	180.0	180.0	18.0

Device	Package Type	Package Drawing	Pins	SPQ	Length (mm)	Width (mm)	Height (mm)
TPS76318DBVT	SOT-23	DBV	5	250	200.0	183.0	25.0
TPS76325DBVR	SOT-23	DBV	5	3000	180.0	180.0	18.0
TPS76325DBVT	SOT-23	DBV	5	250	180.0	180.0	18.0
TPS76327DBVR	SOT-23	DBV	5	3000	180.0	180.0	18.0
TPS76327DBVT	SOT-23	DBV	5	250	180.0	180.0	18.0
TPS76328DBVR	SOT-23	DBV	5	3000	180.0	180.0	18.0
TPS76328DBVT	SOT-23	DBV	5	250	180.0	180.0	18.0
TPS76330DBVR	SOT-23	DBV	5	3000	180.0	180.0	18.0
TPS76330DBVT	SOT-23	DBV	5	250	180.0	180.0	18.0
TPS76333DBVR	SOT-23	DBV	5	3000	200.0	183.0	25.0
TPS76333DBVR	SOT-23	DBV	5	3000	180.0	180.0	18.0
TPS76333DBVT	SOT-23	DBV	5	250	180.0	180.0	18.0
TPS76333DBVT	SOT-23	DBV	5	250	200.0	183.0	25.0
TPS76338DBVR	SOT-23	DBV	5	3000	180.0	180.0	18.0
TPS76338DBVT	SOT-23	DBV	5	250	180.0	180.0	18.0
TPS76350DBVR	SOT-23	DBV	5	3000	180.0	180.0	18.0
TPS76350DBVT	SOT-23	DBV	5	250	180.0	180.0	18.0

DBV0005A



PACKAGE OUTLINE

SOT-23 - 1.45 mm max height

SMALL OUTLINE TRANSISTOR

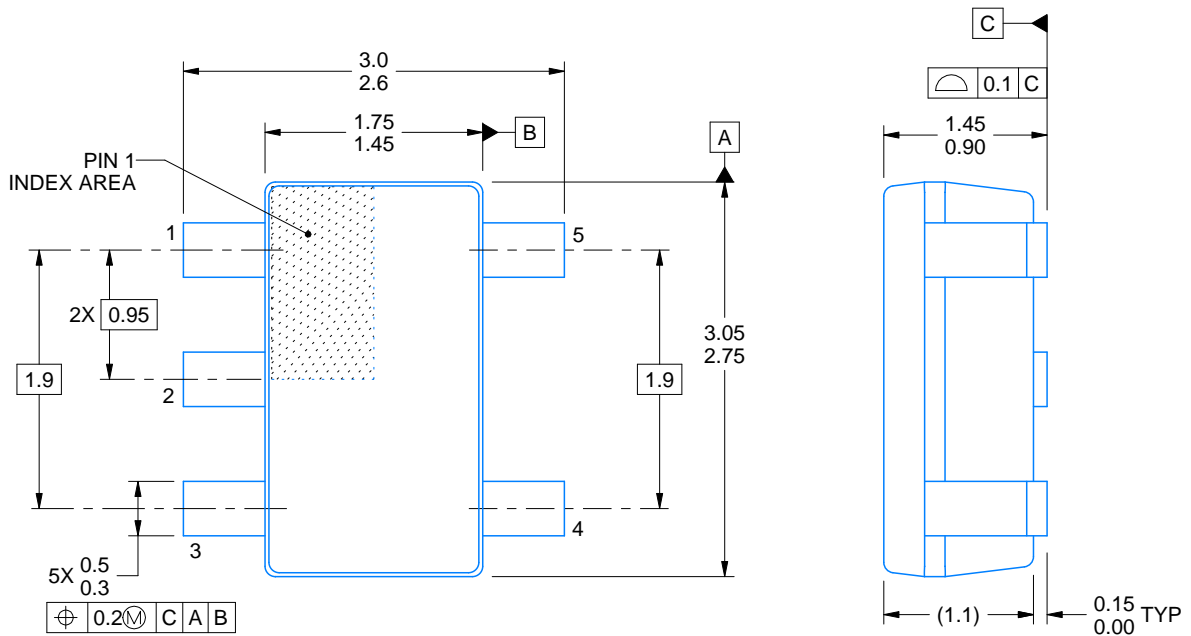

4214839/F 06/2021

NOTES:

1. All linear dimensions are in millimeters. Any dimensions in parenthesis are for reference only. Dimensioning and tolerancing per ASME Y14.5M.
2. This drawing is subject to change without notice.
3. Reference JEDEC MO-178.
4. Body dimensions do not include mold flash, protrusions, or gate burrs. Mold flash, protrusions, or gate burrs shall not exceed 0.25 mm per side.

EXAMPLE BOARD LAYOUT

DBV0005A

SOT-23 - 1.45 mm max height

SMALL OUTLINE TRANSISTOR



LAND PATTERN EXAMPLE
EXPOSED METAL SHOWN
SCALE:15X



SOLDER MASK DETAILS

4214839/F 06/2021

NOTES: (continued)

- 5. Publication IPC-7351 may have alternate designs.
- 6. Solder mask tolerances between and around signal pads can vary based on board fabrication site.

EXAMPLE STENCIL DESIGN

DBV0005A

SOT-23 - 1.45 mm max height

SMALL OUTLINE TRANSISTOR



SOLDER PASTE EXAMPLE
BASED ON 0.125 mm THICK STENCIL
SCALE:15X

4214839/F 06/2021

NOTES: (continued)

7. Laser cutting apertures with trapezoidal walls and rounded corners may offer better paste release. IPC-7525 may have alternate design recommendations.
8. Board assembly site may have different recommendations for stencil design.

重要声明和免责声明

TI“按原样”提供技术和可靠性数据（包括数据表）、设计资源（包括参考设计）、应用或其他设计建议、网络工具、安全信息和其他资源，不保证没有瑕疵且不做任何明示或暗示的担保，包括但不限于对适销性、某特定用途方面的适用性或不侵犯任何第三方知识产权的暗示担保。

这些资源可供使用 TI 产品进行设计的熟练开发人员使用。您将自行承担以下全部责任：(1) 针对您的应用选择合适的 TI 产品，(2) 设计、验证并测试您的应用，(3) 确保您的应用满足相应标准以及任何其他功能安全、信息安全、监管或其他要求。

这些资源如有变更，恕不另行通知。TI 授权您仅可将这些资源用于研发本资源所述的 TI 产品的应用。严禁对这些资源进行其他复制或展示。您无权使用任何其他 TI 知识产权或任何第三方知识产权。您应全额赔偿因在这些资源的使用中对 TI 及其代表造成的任何索赔、损害、成本、损失和债务，TI 对此概不负责。

TI 提供的产品受 [TI 的销售条款](#) 或 [ti.com](#) 上其他适用条款/TI 产品随附的其他适用条款的约束。TI 提供这些资源并不会扩展或以其他方式更改 TI 针对 TI 产品发布的适用的担保或担保免责声明。

TI 反对并拒绝您可能提出的任何其他或不同的条款。

邮寄地址：Texas Instruments, Post Office Box 655303, Dallas, Texas 75265
Copyright © 2021，德州仪器 (TI) 公司