

**Makes it easy to measure low-light emission
from living organisms, cells and foods**



C13796 + A9859

C13796 + A9859-01

C13796 + A9861

C13796 + A9860 + A9861

C13796 + A10490 + A9861

C13796 + A11044

The photon detection unit C13796 is a single photon counting unit that is designed for counting low light emission without special set-up. All users need to prepare the sample and a personal computer (PC) only. The USB interface built-in the C13796 allows simple plug & play set-up.

Six optional modular units (sold separately) are available. The users can select the best one meeting with the purpose/application. When combined with the optional modular units, the C13796 is ideal for various measurements.

APPLICATIONS

- Bioluminescence, chemiluminescence
- Food oxidation, antioxidant activity luminescence
- Activated cell luminescence
- UV-excited (UV LED) delayed fluorescence
- ATP monitor with reagent
- Other low-light-level measurements

FEATURES

- **3 times higher sensitivity than the previous model**
- **Photon counting with high SN ratio**
Low noise: 50 s⁻¹ (Typ. at +25 °C)
- **Built-in USB interface**
- **Interlock function**
Automatically closes optical shutter to prevent excessive light from entering PMT if sample compartment is accidentally opened during measurement.
- **Optical fiber (FC type) compatible**
- **Built-in UV LED excitation light source**
Light source wavelength: 375 nm
Output power: 10 mW/cm²
Irradiation time: 0.1 to 3600 seconds
- **Reagent dispensing**
Dispenses two types of reagents using syringe, pipette as a dispenser
- **CE marking compliance**

APPLICATIONS

●Evaluating compost maturity

Organic farming is the focus of much recent attention, and is a field where the market value of good quality compost is on the rise. To ensure that good quality compost can be quickly supplied when needed, photon detection units are used in research to develop techniques for determining compost maturity during the compost purification process. Focusing on the fact that good quality compost is oxidized excrement, researchers added oxygen to liquid extracted from compost during the fermentation process to accelerate oxidation of residual organic matter and then rated the maturation from the intensity of low-level luminescence emitted during the oxidation process. Good quality compost has less unoxidized material and so emits low-level luminescence.

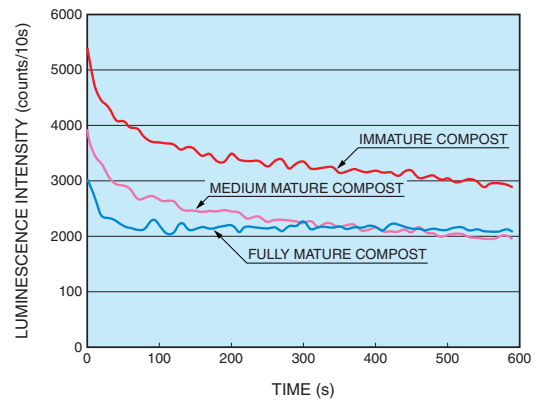
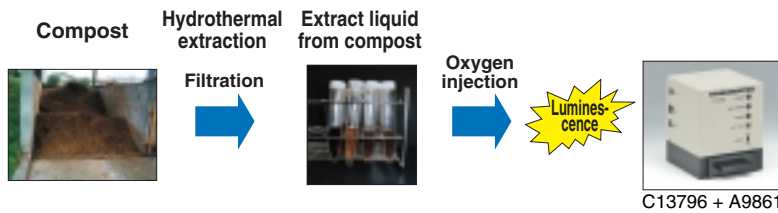

Data courtesy of:
Nobuya Katayama, Shizuoka Prefectural Animal Husbandry Experiment Station
Mayuko Iwai, Graduate School for Creation of New Photonics Industries

●Diagnosing fungus-infected plants

Photon detection units are utilized in research to develop techniques for detecting the low level luminescence emitted from honey fungus which is a type of mushroom that acts as a parasite and eats into road-side trees. These techniques will serve as tests to diagnose whether a tree is infected with fungal filaments (hypha). Samples taken from the bark of the suspect tree are measured using a photon detection unit. The material within the tree bark being eaten away by the fungus undergoes a temperature change due to fungal action so that the luminescence intensity rises with the passage of time. Utilizing these changes in low-level luminescence intensity reveals whether there is fungal infection or not.



Upper: Honey fungus (fruited body: luminescence cannot be observed visually)
Left: Image observed on fungus culture under bright conditions
Right: Image observed on fungus culture under dark conditions (luminescence can be observed visually)

Results from measuring luminescence intensity on fruited body impossible to observe visually over elapsed time

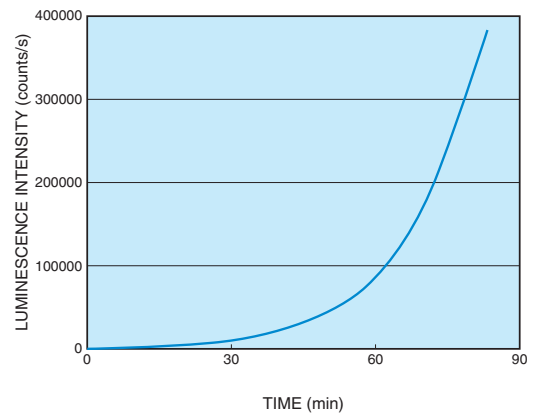

Data courtesy of:
Masaru Hiroi, Koriyama Women's University & College

●Oxidization on one polished rice grain

The delayed fluorescence intensity from the surface of a single polished rice grain irradiated with UV light for 10 seconds is measured using a photon detection unit that contains an excitation light source and is operated with dedicated software. This measurement yielded a specific value for progressive oxidation after rice milling with the passage of time.



C13796 + A9860 + A9861

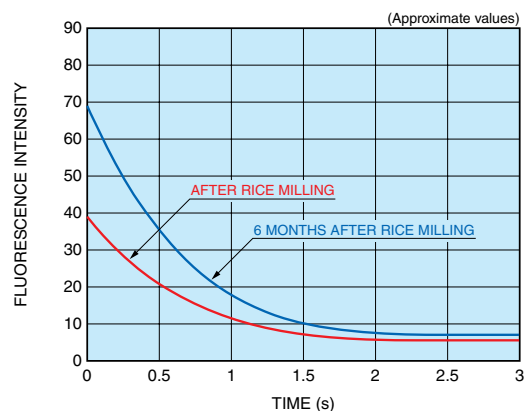
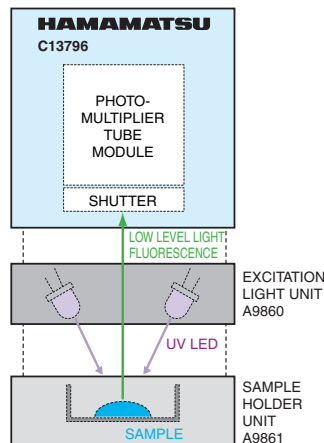

● **Luminescence level in ATP method and changes in *koji* aspergillus body mass during cultivation of rice *koji***

Photon detection units were used to measure the luminescence level in the APT method and changes in *koji* aspergillus body mass of rice *koji* cultivated based on the standard *koji* making test.

Comparing the luminescence level in the APT method with the *koji* aspergillus body mass, they show similar changes up to 32 consecutive hours of rice *koji* cultivation. Changes in the rice body mass and enzymatic activity (alpha-amylase) are major quality indicators of *koji* aspergillus and mainly end during the logarithmic growth phase, so how both methods related was compared in a range of the culture time from 12 to 32 hours, which is a transition to the stationary phase. Although the number of data was small, the results clearly showed a high correlation.



C13796 + A11044

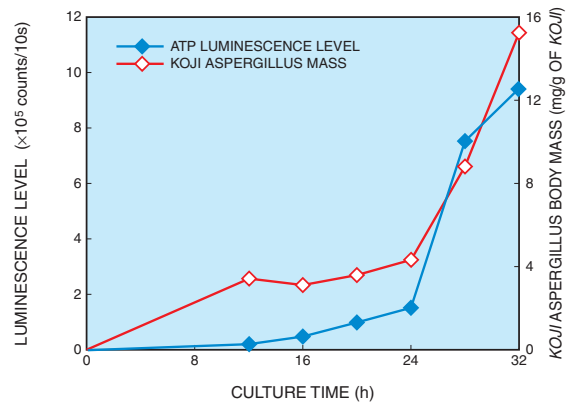

Data courtesy of: Prof. Takahiro Saito, Faculty of Agriculture, Department of Environmental Engineering, Utsunomiya University

● **Viable bacteria count versus luminescence level in ATP method on fresh produce**

Photon detection units are used in research to find techniques using chemiluminescence for quickly and easily measuring the degree of purity in food.

About 3 leaves each taken from the outermost layer of several pieces of Boston lettuce were thoroughly crushed and diluted about 10 times with distilled sterile water for use as the sample fluid concentrate and the luminescence intensity measured by the ATP method using the photon detection unit. The number of viable bacteria cultured by the official analytical method was then found and the correlation with the luminescence level found.



C13796 + A11044

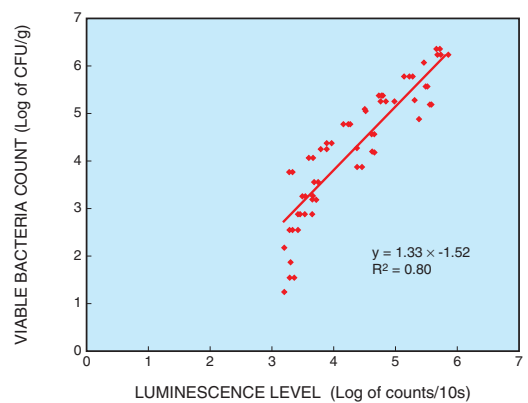

Data courtesy of: Prof. Takahiro Saito, Faculty of Agriculture, Department of Environmental Engineering, Utsunomiya University

● **Evaluation of refined *sake* deterioration**

Refined *sake* (rice wine) oxidizes or in other words degrades after the container or bottle is opened. This oxidation was evaluated with photon detection units utilizing the following two methods.

Evaluation by XYZ measurement system (upper graph)

The degradation (or oxidation) occurring in refined *sake* was evaluated by ranking refined *sake* as reactive oxygen species (X) and using a mixture of anti-oxidation species (Y) and receptor species (Z).

Evaluation by oxidation reaction measurement system (lower graph)

The degradation (or oxidation) occurring in refined *sake* was evaluated using a mixture of 75 microliters of hypochlorous sodium to 3 milliliters of refined *sake*.

In both methods the luminescence intensity (degradation level) rose in proportion to the number of days in storage.

Left standing
in 30 °C
environment



C13796 + A10490 + A9861

Evaluation by XYZ measurement system

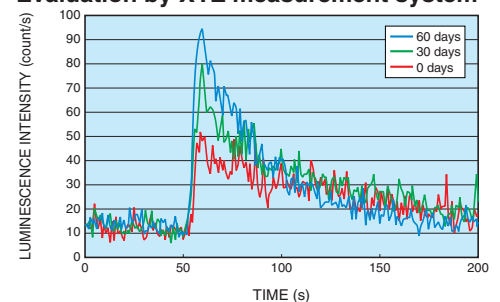

Evaluation by oxidation reaction measurement system

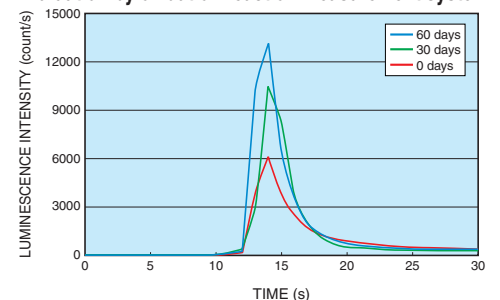

Data courtesy of: Prof. Takahiro Saito, Faculty of Agriculture, Department of Environmental Engineering, Utsunomiya University

PHOTON DETECTION UNIT C13796

SPECIFICATIONS

C13796-A1* (with AC adaptor for Japan) *A2: For North America, A3: For Europe

Parameter		Description / Value	Unit
Detection method		Photon counting method	—
Spectral response range		300 to 650 [Ⓐ]	nm
Photocathode size		φ22	mm
Max. count rate at 10 % count loss		3 × 10 ⁶	s ⁻¹
Counter gate time		0.001 to 10 (1, 2, 5 Steps)	s
Max. measurement point (with sample software)		1,000,000	—
Dark count (Typ. at +25 °C)		50 [Ⓐ]	s ⁻¹
Counter capacity		32 bit/gate	—
Trigger section	Trigger signal input mode	External trigger, software trigger	—
	Trigger signal level	TTL negative logic	—
	Trigger signal pulse width	100 ns or more	—
Input voltage (DC)		+7 (supplied from AC adapter)	V
Input voltage (AC) to supplied AC adapter		100 V to 240 V (auto switchable), single phase 50 Hz/60 Hz	—
Operating	Temperature	+5 to +40	°C
	Humidity	Below 80 (no condensation)	%
Storage	Temperature	0 to +50	°C
	Humidity	Below 85 (no condensation)	%
OS		Windows [®] Vista Business (32 bit), 7 Pro (32/64 bit), 8 Pro (32/64 bit), 8.1 Pro (32/64 bit)	—
Interface		USB Ver1.1	—

NOTE: [Ⓐ]Option available for 300 nm to 850 nm spectral response range (Dark counts 5000 s⁻¹ typical).

Accessories (Supplied): ●CD-ROM (control software) ●USB cable (2.0 m) ●AC adapter ●Cable for external trigger (1.5 m)

C13796 + A9859 (Optical fiber panel)

Parameter		Description / Value	Unit
Optical fiber adapter		FC type (HRFC-R1/Hirose)	—
Distance to photocathode		15.0 (from fiber end)	mm
Weight		Approx. 1.1	kg

C13796 + A9859-01 (Optical block panel)

Parameter		Description / Value	Unit
Suitable optical block		V-groove type	—
Distance to photocathode		17.3	mm
Weight		Approx. 1.1	kg

C13796 + A9861 (Sample holder unit)

Parameter		Description / Value	Unit
Effective size of sample compartment (W × D × H)		50 × 50 × 15	mm
Distance to photocathode		26.5 (from bottom of sample compartment)	mm
Weight		Approx. 1.4	kg

C13796 + A9860 + A9861 (Excitation light source unit + Sample holder unit)

Parameter		Description / Value	Unit
Excitation light source (UV LED)	Wavelength · Output power	375 nm · 10 mW/cm ²	—
	Irradiation time	0.1 to 3600	s
	Irradiation area	φ10 (center of sample compartment)	mm
Effective size of sample compartment (W × D × H)		50 × 50 × 15	mm
Distance to photocathode		43.5 (from bottom of sample compartment)	mm
Weight		Approx. 1.6	kg

C13796 + A10490 + A9861 (Dispenser unit + Sample holder unit)

Parameter		Description / Value	Unit
Suitable syringe capacity		5 (Terumo [®] syringe) [Ⓑ]	ml
Needle size		Outer diameter: 1 mm, inner diameter: 0.6 mm	—
Recommended gas flow tube		Outer diameter: 6 mm (Black tube is recommended for light shielding)	—
Distance to photocathode		43.5	mm
Weight		Approx. 1.6	kg

NOTE: [Ⓑ]Please prepare at customer side

C13796 + A11044 (Microtube unit)

Parameter		Description / Value	Unit
Suitable microtube		500	μl
Distance to photocathode (to microtube surface)		17.0	mm
Weight		Approx. 1.7	kg

SETUP DIAGRAMS

●C13796 + A9859

Major applications: Various measurements using optical fiber (FC type)

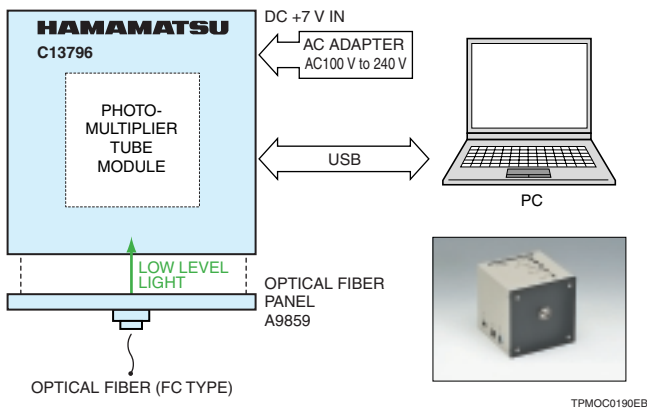

●C13796 + A9859-01

Major applications: Various measurements using optical blocks

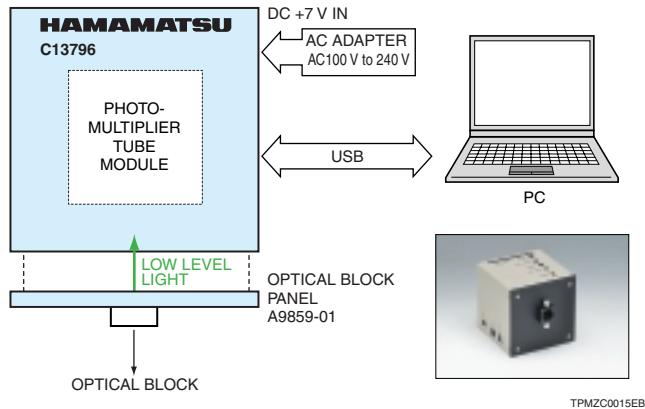

●C13796 + A9861

Major applications: Bioluminescence, chemiluminescence

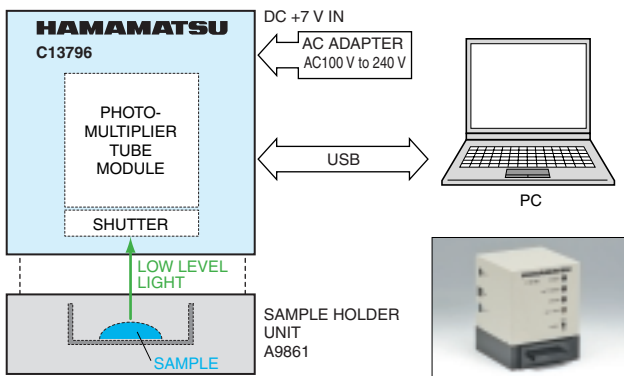

●C13796 + A9860 + A9861

Major applications: Fluorescence life time, delayed fluorescence

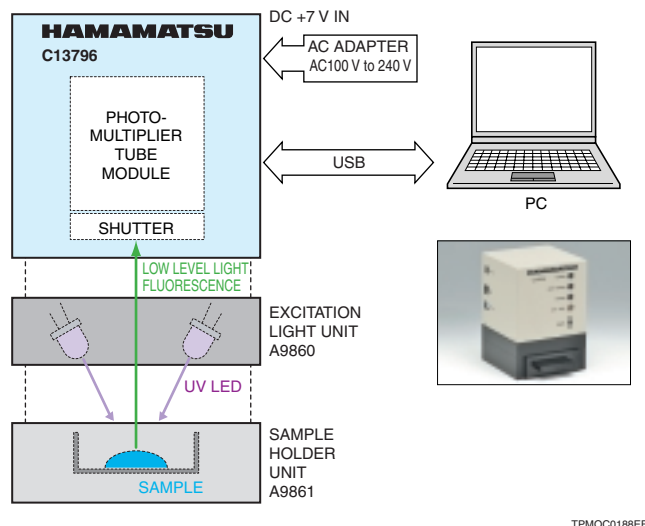

●C13796 + A10490 + A9861

Major applications: Chemiluminescence using syringe

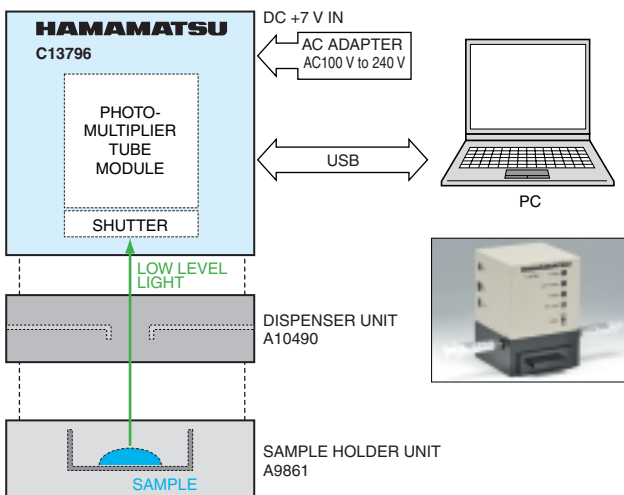

●C13796 + A11044

Major applications: Chemiluminescence using pipette

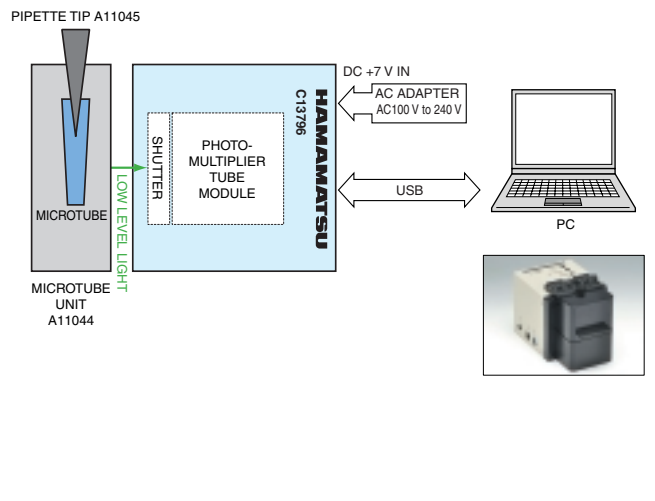

PHOTON DETECTION UNIT C13796

DIMENSIONAL OUTLINE (Unit: mm)

●C13796 + A9859

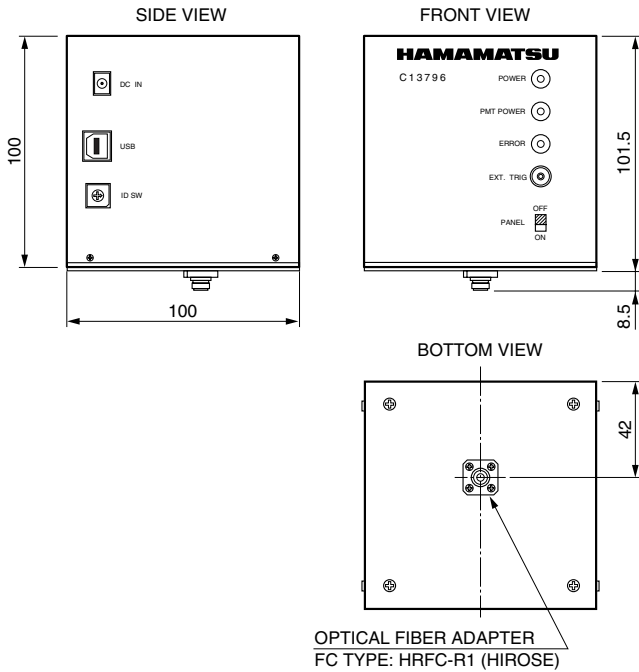

TPMOA0033EB

●C13796 + A9859-01

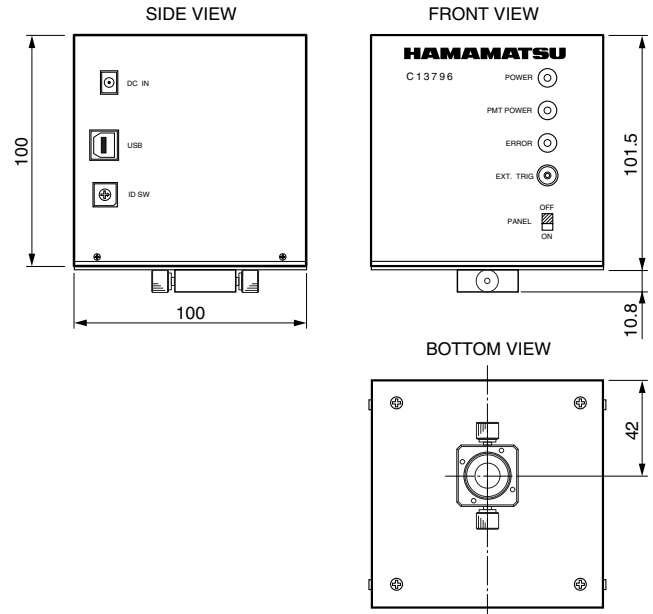

TPMZA0013EC

●C13796 + A9861

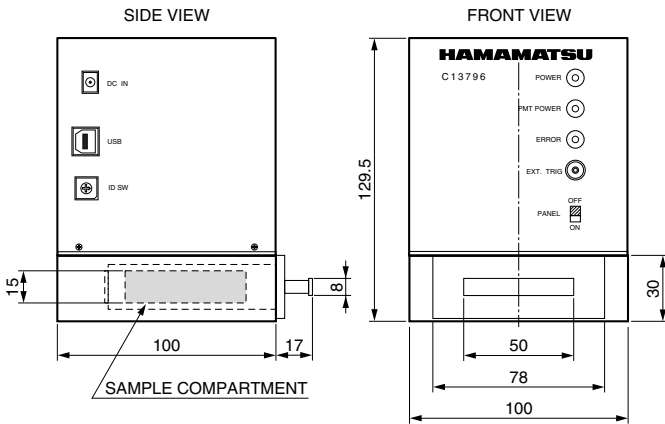

TPMOA0034EB

●C13796 + A9860 + A9861

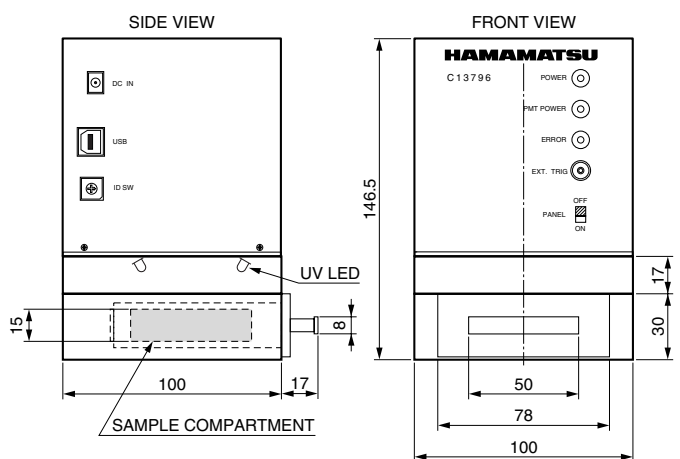

TPMOA0035EB

●C13796 + A10490 + A9861

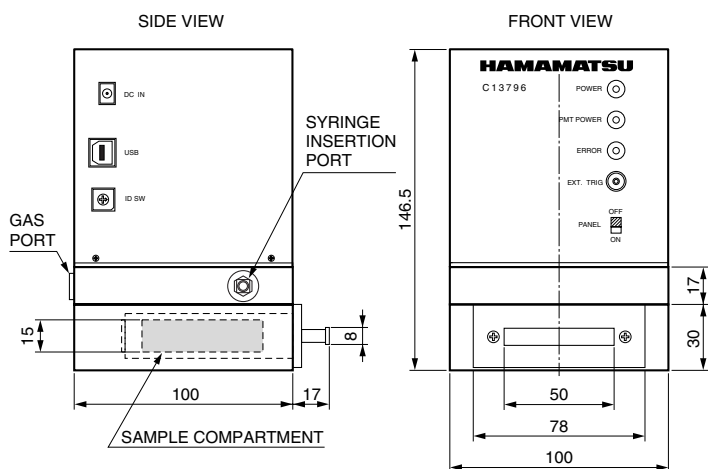

TPMOA0045EA

●A9861 Sample compartment tray

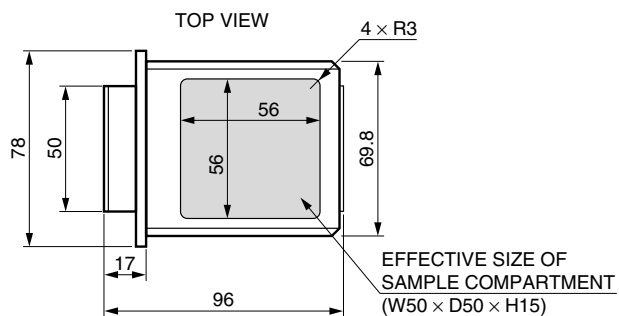

TPMOA0034EA / TPMOA0035EA / TPMOA0045EA

●C13796 + A11044

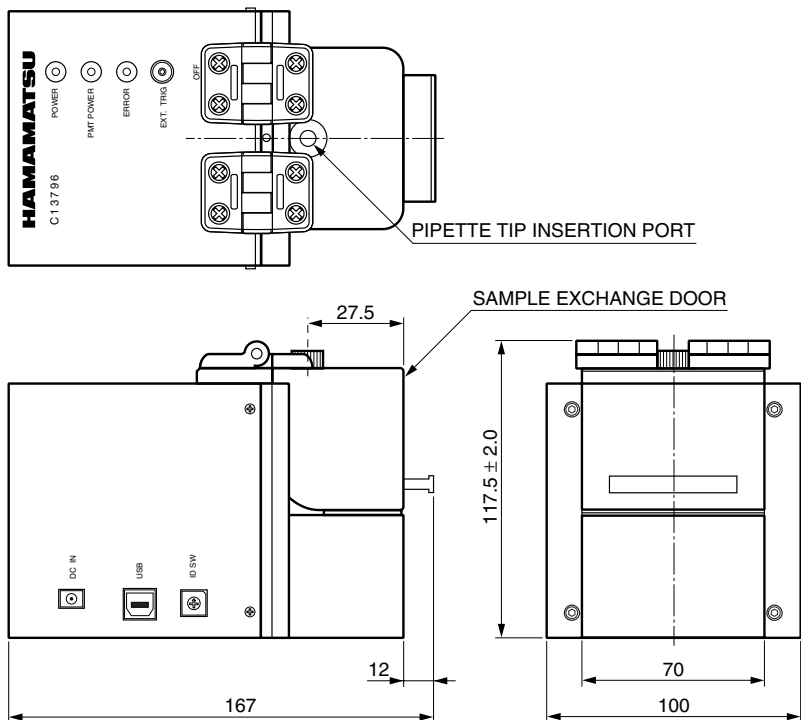

TPMOA0003EB

Guide of Type No. for AC adapter

C13796-A□

"□" Type No.

- 1: For Japan
- 2: For North America
- 3: For Europe

PHOTON DETECTION UNIT C13796



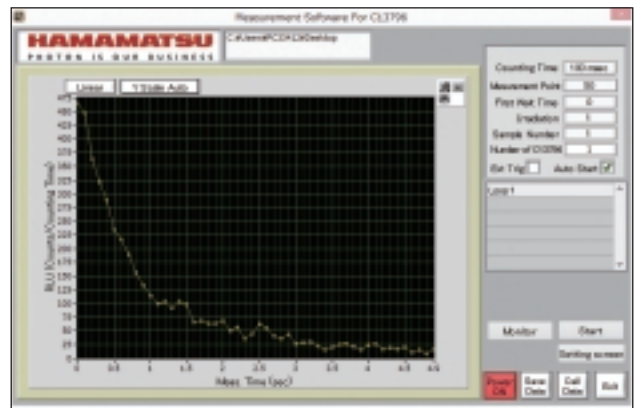

CONTROL SOFTWARE FUNCTIONS

- **Time-resolved measurement**
Resolves measurement time per unit time (1 ms or more) allowing measurement of various light emission patterns.
- **Optical shutter control**
Opens or closes optical shutter for excess light protection and dark current pulse measurement.
- **Data display during measurement**
Continuously transfers measurement data to PC for data monitoring.
- **Measurement data save**
Saves measurement data in Excel® format to make data analysis easier.

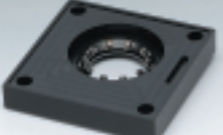
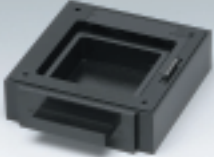

OPTIONAL MODULAR UNITS (sold separately)

Please select following options depending on the purpose application.

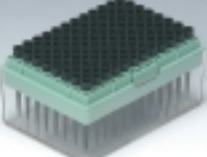
Optical fiber panel A9859 	Optical block panel A9859-01 * 	Excitation light source unit A9860 	Sample holder unit A9861 
Disperser unit A10490 	Microtube unit A11044 	Pipette tips A11045 	* Optical block panels can be combined with various types of optical blocks. Optical blocks are modular units that accommodate optical components such as band-pass filters designed for use with this C13796 photon detection unit.

Windows® is a registered trademark of Microsoft Corporation in the United States and/or other countries.
Other product names, software names and company names mentioned herein may be the trademarks of their respective owners.

HAMAMATSU PHOTONICS K.K. www.hamamatsu.com

HAMAMATSU PHOTONICS K.K., Electron Tube Division
314-5, Shimokanzo, Iwata City, Shizuoka Pref., 438-0193, Japan, Telephone: (81)539/62-5248, Fax: (81)539/62-2205

U.S.A.: Hamamatsu Corporation: 360 Foothill Road, Bridgewater, N.J. 08807-0910, U.S.A., Telephone: (1)908-231-0960, Fax: (1)908-231-1218 E-mail: usa@hamamatsu.com
Germany: Hamamatsu Photonics Deutschland GmbH: Arzbergerstr. 10, D-82211 Herrsching am Ammersee, Germany, Telephone: (49)8152-375-0, Fax: (49)8152-2658 E-mail: info@hamamatsu.de
France: Hamamatsu Photonics France S.A.R.L.: 19, Rue du Saule Trapu, Parc du Moulin de Massy, 91882 Massy Cedex, France, Telephone: (33)1 69 53 71 00, Fax: (33)1 69 53 71 10 E-mail: infos@hamamatsu.fr
United Kingdom: Hamamatsu Photonics UK Limited: 2 Howard Court, 10 Tewin Road, Welwyn Garden City, Hertfordshire AL7 1BW, United Kingdom, Telephone: (44)1707-294888, Fax: (44)1707-325777 E-mail: info@hamamatsu.co.uk
North Europe: Hamamatsu Photonics Norden AB: Torshamnsgatan 35 SE-164 40 Kista, Sweden, Telephone: (46)8-509-031-00, Fax: (46)8-509-031-01 E-mail: info@hamamatsu.se
Italy: Hamamatsu Photonics Italia S.r.l.: Strada della Moia, 1 int. 6, 20020 Arese (Milano), Italy, Telephone: (39)02-93581733, Fax: (39)02-93581741 E-mail: info@hamamatsu.it
China: Hamamatsu Photonics (China) Co., Ltd.: B1201 Jiaming Center, No.27 Dongsanhuan Beilu, Chaoyang District, Beijing 100020, China, Telephone: (86)10-6586-6006, Fax: (86)10-6586-2866 E-mail: hpc@hamamatsu.com.cn
Taiwan: Hamamatsu Photonics Taiwan Co., Ltd.: 8F-3, No.158, Section2, Gongdao 5th Road, East District, Hsinchu, 300, Taiwan R.O.C. Telephone: (886)03-659-0080, Fax: (886)07-811-7238 E-mail: info@tw.hpk.co.jp

TPMZ1025E01
DEC. 2016 IP