

Thermoelectric Coolers

High Performance Thermoelectric Coolers C10372, C10373 For 28 mm, 38 mm, 51 mm Diameter Head-on PMT and MCP-PMT



Left: Power Supply
Right: Cooled PMT Housing

The C10372 series and C10373 series are water-cooled thermoelectric coolers designed to reduce thermal electrons emitted from the photocathode of photomultiplier tubes (PMTs) in order to improve signal-to-noise ratio (S/N ratio). The C10372 series further contains an electrostatic and magnetic shield that minimizes the influence of the ambient environment. The C10372 series are for 28 mm, 38 mm and 51 mm diameter head-on PMTs, while the C10373 series are for MCP-PMTs.

Features

- Thermoelectric cooling using Peltier module
- About -30 °C cooling temperature (with +20 °C cooling water)
- Evacuated, double-pane window with heater for frost prevention
- Built-in electrostatic and magnetic shielding (C10372 series)
- Internal protective circuits safeguards Peltier module in case of low water
- Internal protective circuits prevent output short-circuit, output overvoltage, and excessive temperature rise in power supply
- Stable operation due to a regulated power supply

Specifications

[Cooled PMT Housing]

Parameter	C10372-01/-02 [Ⓐ]	C10373-01/-02 [Ⓐ]	Unit
Cooling Method	Thermoelectric cooling using Peltier module		—
Heat Exchange Medium	Water (1 L/min to 3 L/min, water pressure: below 0.3 MPa)		—
Cooling Temperature (with cooling water at +20 °C)	Approx. -30		°C
Time to Stable Cooling Temperature	Approx. 120		min
Optical Window Material	Evacuated double-pane synthetic silica window with heater (185 nm to 2200 nm)		—
Applicable PMTs (sold separately)	28 mm (1-1/8") Dia., 38 mm (1-1/2") Dia. and 51 mm (2") Dia. Head-on	MCP-PMT (R3809U-50 Series, R3809U-61/-63/-64)	—
Applicable Socket Assembly / Holder (sold separately)	E2762 Series [Ⓑ]	E3059-500 (R3809U-50 Series, R3809U-61/-63/-64)	—
Operating Ambient Temperature / Humidity [Ⓒ]	+5 °C to +40 °C / Below 75 %		—
Storage Temperature / Humidity [Ⓒ]	-15 °C to +50 °C / Below 80 %		—
Weight	Approx. 5.8	Approx. 5.5	kg

NOTE: [Ⓐ]C10372 / C10373: For AC 100 V operation. C10372-01 / C10373-01: For AC 120 V operation. C10372-02 / C10373-02: For AC 230 V operation.
[Ⓑ]See P.119 [Ⓒ]No condensation

[Power Supply]

Parameter	Value / Description	Unit
AC Input Voltage	100 to 240 (± 10 %) (50 Hz/60 Hz)	V
Maximum Power Consumption	200	V·A
Temperature Controllable Range (with cooling water at +20 °C)	-30 to 0 (continuously adjustable)	°C
Output Voltage	24 to 27	V
Output Current	4.2	A
Protection Circuit	Protective circuits to safeguard Peltier module in case of low water and to prevent output short-circuit, output overvoltage, and excessive temperature rise in power supply.	—
Operating Ambient Temperature / Humidity [Ⓒ]	+5 °C to +40 °C / Below 75 %	—
Storage Temperature / Humidity [Ⓒ]	-15 °C to +50 °C / Below 80 %	—
Weight	Approx. 2.1	kg

NOTE: [Ⓒ]No condensation

[Components and Accessories]

- Cooled PMT housing ● Power supply ● Light shield cap ● Water hose clamps (2 pcs) ● Connection cable (1.5 m)
- AC line cable (2.5 m: -02 type, 2.0 m: other types) ● Socket assembly / PMT holder mounting screws (4 pcs)

* To use these coolers, water hoses with an inner diameter of 15 mm and a water supply line with the matching round faucet are required. Prepare those hoses of the desired length. Hoses can also be connected by using PT 1/8 pipe taper screws.

** **CE** C10372 series and C10373 series conform to the EMC directive and the LVD of the European Union.

Cooling Characteristics

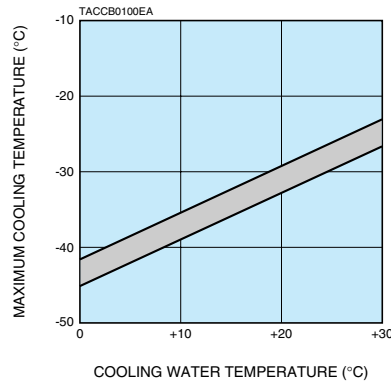
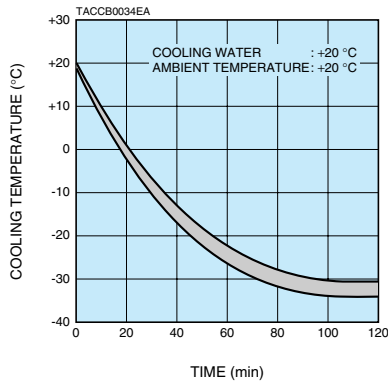

Spectral Transmission Characteristics of Optical Window

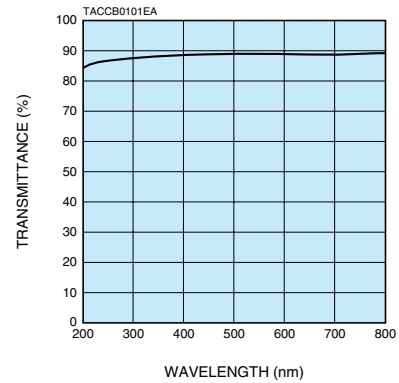

Dimensional Outlines (Unit: mm)

HOUSING

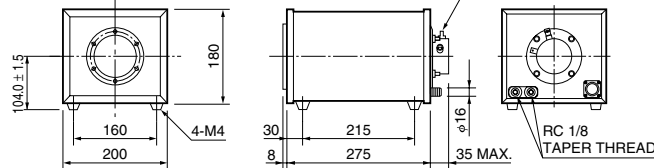

E2762 SERIES (Sold Separately)

POWER SUPPLY

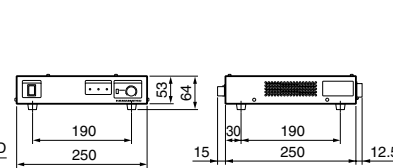

* The 1 mm thickness of the folded aluminum plate is not included in.

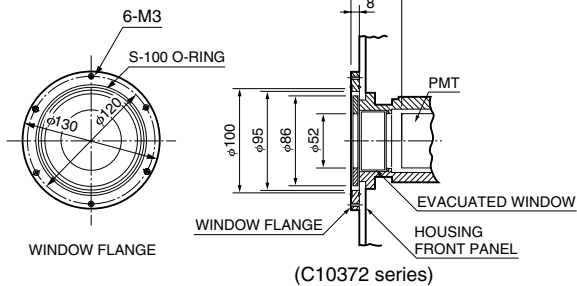

TACCA0292EB

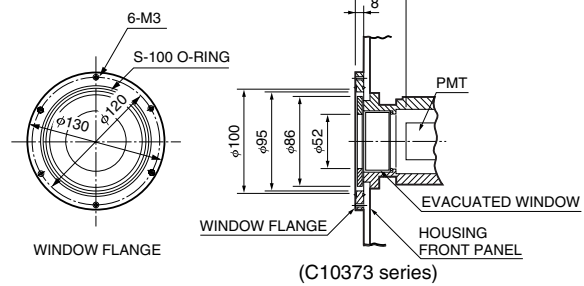

TACCA0293EB

Sold Separately (Unit: mm)

Socket Assemblies for C10372 Series E2762 Series

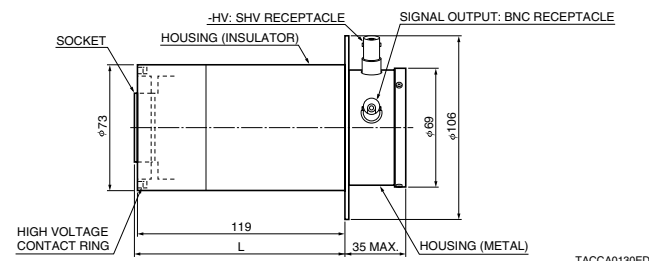

TACCA0130ED

L: E2762-502...133.5 E2762-510...106.5 * The high voltage contact ring is used for internal electrical connection to the magnetic shield case in the cooler.
 E2762-506...144.5 E2762-511...120.5
 E2762-509...106.5 E2762-513...120.5

MCP-PMT Holder for C10373 Series E3059-500 (For R3809U Series)

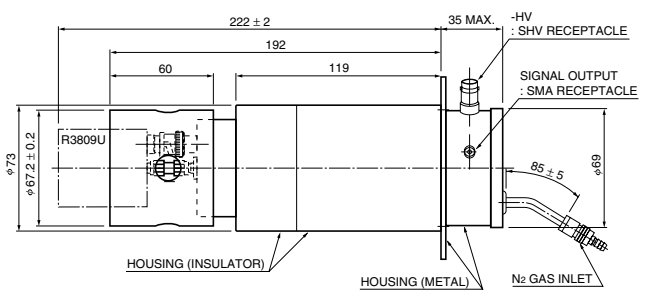

TACCA0133EC

NOTE: (A)

E2762 Series	PMT
E2762-502	R11102, R2066, etc.
E2762-506	R943-02
E2762-509	R464, R649, etc.
E2762-510	R329-02, R331-05, R2257, etc.
E2762-511	R374, R2228, R5929, etc.
E2762-513	R375, R669

Thermoelectric Coolers

High Performance Thermoelectric Coolers for 28 mm Dia. Side-on PMTs C9143, C9144 Series

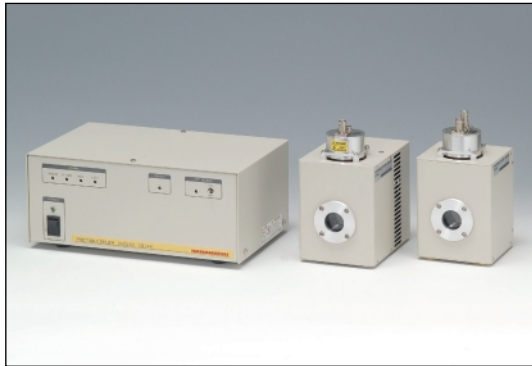

▲Left: Controller for C9144 and C9143
Center: C9144 and socket assembly C9145
Right: C9143 and socket assembly E9146

The C9143 and the C9144 are thermoelectric coolers designed for 28mm diameter side-on photomultiplier tubes (PMT). The C9143 and the C9144 improve S/N (signal to noise ratio) of PMT measurement because of reduction of thermal electrons, which are emitted from PMT photocathode, and minimization of external noise by a built-in electrostatic and magnetic shield. The C9143 and the C9144 can communicate with a PC via an RS-232C serial interface. It enables the PC to control the cooling temperature, high voltage output of C9145 (optionally available socket assembly with a built in Cockcroft-Wolton high voltage power supply) and ± 5 V power supply for external equipment. The C9143 and the C9144 use water and forced air respectively to exchange heat of the thermoelectric cooler (Peltier module).

Features

- Thermoelectric cooling using Peltier module
- Built-in electrostatic and magnetic shield
- Internal protective circuits safeguards Peltier module in case of low water flow or suspension of fan operation
- Low voltage output for driving C9145 (sold separately)
- Control and monitor function of high voltage output of C9145
- ± 5 V output for external equipment
- Built-in interface for controlling external equipment (D-Sub)
- PMT temperature control by PC

Specifications

[Cooled PMT Housing]

Parameter	C9143/-01/-02 [Ⓐ]	C9144/-01/-02 [Ⓐ]	Unit
Cooling Method	Thermoelectric cooling using Peltier module		—
Heat Exchange Medium	Water	Forced air	—
Cooling Temperature	Approx. -30 [Ⓑ] (with cooling water of +20 °C)	Approx. -25 [Ⓒ] (with ambient temperature of +25 °C)	°C
Maximum Cooling Temperature	-30		°C
Time to Stable Cooling Temperature	Approx. 70	Approx. 90	min
Optical Window Material	Evacuated double-pane synthetic silica (185 nm to 2200 nm)		—
Light Input Aperture Dimension	8 × 24		mm
Applicable PMTs (sold separately)	28 mm Dia. Side-on Type		—
Applicable Socket Assembly (sold separately)	C9145 (DP-type), E9146 (D-type)		—
Operating Ambient Temperature / Humidity [Ⓓ]	+5 °C to +40 °C / Below 75 %	+5 °C to +35 °C / Below 75 %	—
Storage Temperature / Humidity [Ⓓ]	-20 °C to +50 °C / Below 85 %		—
Weight	Approx. 1	Approx. 1.7	kg
Feature	Law infuence by ambient temperature	Easy operation	—

NOTE: [Ⓐ]C9143/C9144: For AC 100 V operation. C9143-01/C9144-01: For AC 120 V operation. C9143-02/C9144-02: For AC 230 V operation. [Ⓑ]C9143 achieves cooling temperature of approx. -30 °C with water temperature of +20 °C. If the water temperature is higher, the possible lowest cooling temperature becomes higher (Note: Maximum cooling temperature is -30 °C). [Ⓒ]C9144 achieves cooling temperature of approx. -25 °C with ambient temperature of +25 °C. If the ambient temperature is higher, the possible lowest cooling temperature becomes higher. If the ambient temperature is lower, the possible lowest cooling temperature becomes lower (Note: Maximum cooling temperature is -30 °C). [Ⓓ]No condensation

[Controller]

Parameter	Value/Description	Unit
AC Input Voltage	100 to 240 (± 10 %) (50 Hz / 60Hz)	V
Maximum Power Consumption	150	V·A
Temperature Controllable Range	-30 to -5 (0.5 °C step) [Ⓔ]	°C
Protection Circuit	Protective circuits to safeguard Peltier module in case of low water or suspension of fan operation and to prevent output short-circuit, output overvoltage, and excessive temperature rise in controller.	—
Power Supply Unit for External Equipment	Output Voltage	± 5 (± 0.25)
	Output Current	0.5
	Connector	DIN (6 PIN)
Control Interface	DI (Input)	4 bits (TTL input)
	DO (Output)	4 bits (TTL open collector output)
Serial Interface	RS-232C, 9600 bps	—
Operating Temperature / Humidity [Ⓓ]	+5 °C to +40 °C / Below 75 %	—
Storage Temperature / Humidity [Ⓓ]	-20 °C to +50 °C / Below 85 %	—
Weight	Approx. 4	kg

NOTE: [Ⓓ]No condensation [Ⓔ]PMT temperature may not achieve set up cooling temperature controlled by the operator if ambient temperature and/or water temperature is high. The cooling temperature is controlled on personal computer.

[Components and Accessories]

● Cooled PMT housing ● Controller ● Light shield cap ● AC line cable (2.5 m: -02 type, 2 m: other types) ● Connection cable (1.5 m) between cooled PMT housing and controller ● Serial communication cable (RS-232C crossing cable 1.8 m) ● D-Sub 15 pin connector plug ● Cable terminated with a ± 5 V plug (1.5 m, one end unterminated) ● CD-R (Instruction manual, sample software for control of cooling temperature and C9145 voltage) ● Spare fuses (2 pcs)

* To use C9143 series, water hoses with an outer diameter of 6 mm and an inner diameter of 4 mm and a water supply line with the matching round faucet are required. Prepare those hoses of the desired length. In addition, prepare a filter for removing impurities such as chlorine ions.

** CE C9143 series and C9144 series conform to the EMC directive and the LVD of the European Union.

Cooling Characteristics

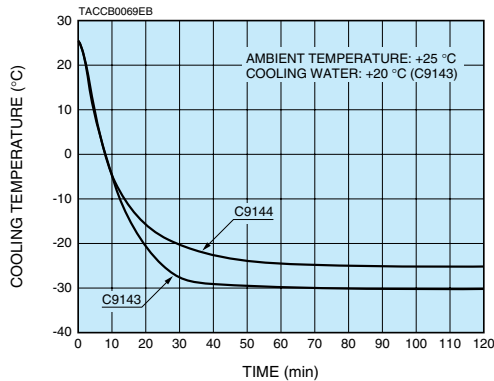

Spectral Transmission Characteristics of Optical Window

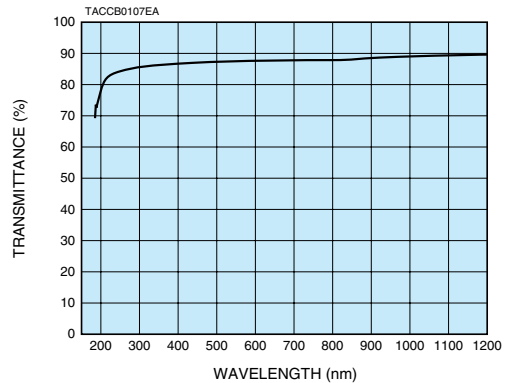

Dimensional Outlines (Unit: mm)

●C9143 HOUSING

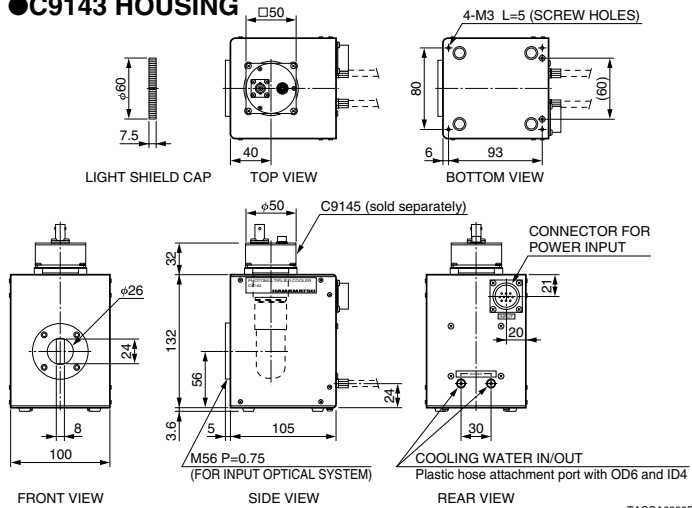

●C9144 HOUSING

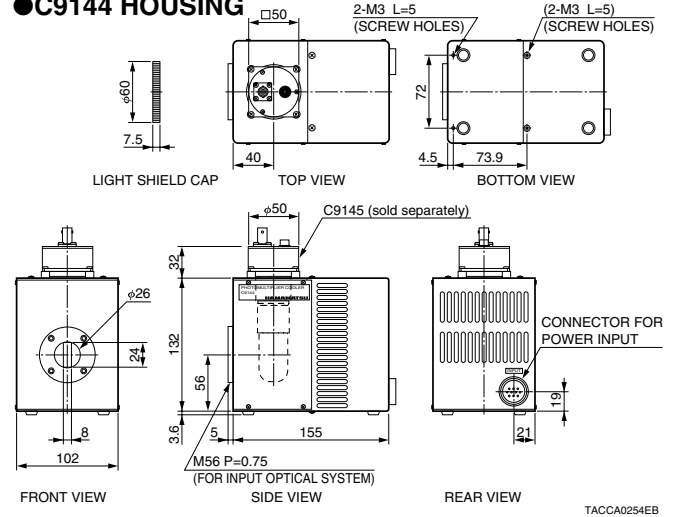

●CONTROLLER

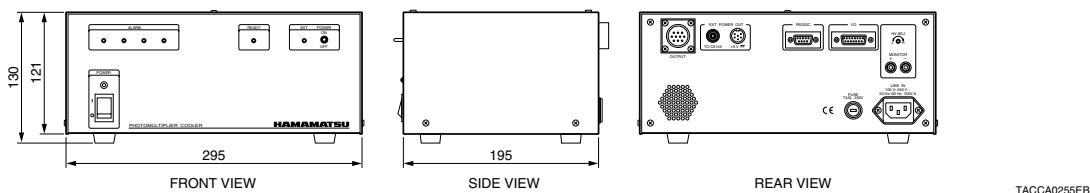

Sold Separately (Unit: mm)

●C9145 (DP Type) *MAXIMUM SUPPLY VOLTAGE: -1200 V

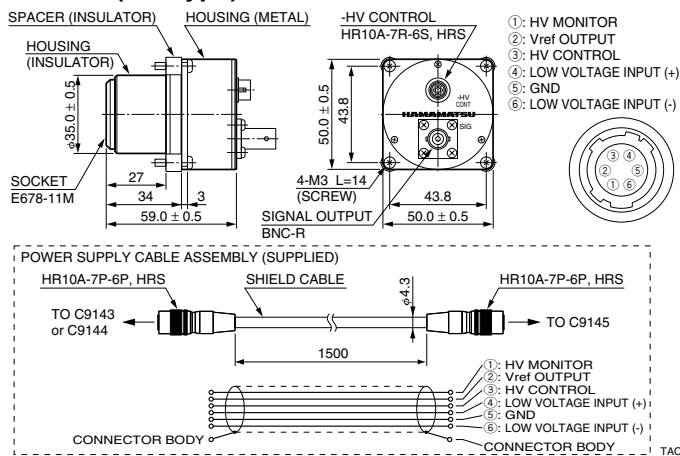

●E9146 (D Type) *MAXIMUM SUPPLY VOLTAGE: -1250 V

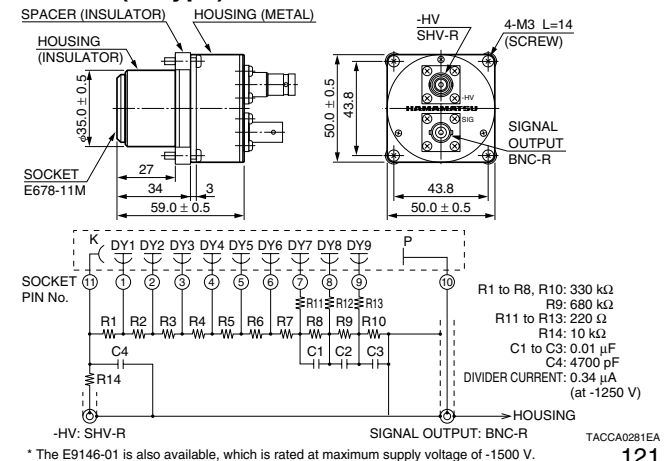

* The E9146-01 is also available, which is rated at maximum supply voltage of -1500 V.