

## S14160/S14161 series

### Low breakdown voltage type MPPC for scintillation detector

The S14160/S14161 series achieve higher PDE (photon detection efficiency) and lower operation voltage than other MPPC to adapt for PET and radiation monitor application. They achieve small dead space in a photosensitive area with HWB (hole wire bonding) technology (Patent pending). And the gap from the photosensitive area edge to the package edge is only 0.2 mm. This package realizes the four-side buttable arrangement.

#### Features

- Higher PDE (50% at  $\lambda_p$ ,  $V_{op}=V_{BR} + 2.7 V$ )
- Lower voltage ( $V_{BR}=38 V$  typ.) operation
- Small dead space in photosensitive area
- Low afterpulses and crosstalk
- High gain:  $10^6$  order
- Excellent time resolution
- Immune to effects of magnetic fields

#### Applications

- PET (positron emission tomography)
- Radiation monitor

#### Structure

Typ. no.	Number of channels (ch)	Effective photosensitive area/channel (mm <sup>2</sup> )	Pixel pitch (μm)	Number of pixels/channel	Package	Window	Window refractive index	Geometrical fill factor (%)
S14160-3050HS	1	3.0 × 3.0	50	3531	Surface mount type	Silicone	1.57	74
S14160-4050HS		4.0 × 4.0		6331				
S14160-6050HS		6.0 × 6.0		14331				
S14161-3050HS-04	16 (4 × 4)	3.0 × 3.0		3531				
S14161-3050HS-08	64 (8 × 8)	3.0 × 3.0		3531				
S14161-4050HS-06	36 (6 × 6)	4.0 × 4.0		6331				
S14161-6050HS-04	16 (4 × 4)	6.0 × 6.0		14331				

#### Absolute maximum ratings

Parameter	Symbol	Specification	Unit
Operating temperature*1	Topr	-40 to +85	°C
Storage temperature*1	Tstg	-40 to +85	°C
Soldering temperature*2	Tsol	240 (3 times)	°C

\*1: No dew condensation

When there is a temperature difference between a product and the surrounding area in high humidity environment, dew condensation may occur on the product surface. Dew condensation may cause deterioration in characteristics and reliability.

\*2: Reflow soldering, JEDEC J-STD-020 MSL 5a, see P.10

Note: Exceeding the absolute maximum ratings even momentarily may cause a drop in product quality. Always be sure to use the product within the absolute maximum ratings.

**Electrical and optical characteristics (Typ. Ta=25 °C, Vover=2.7 V, unless otherwise noted)**

Parameter	Symbol	S14160/S14161 -3050HS-04, -08	S14160/S14161 -4050HS-06	S14160/S14161 -6050HS-04	unit
Spectral response range	$\lambda$	270 to 900			nm
Peak sensitivity wavelength	$\lambda_p$	450			nm
Photon detection efficiency at $\lambda_p^{*3}$	PDE	50			%
Breakdown voltage	VBR	38			V
Recommended operating voltage*4	Vop	VBR + 2.7			V
Vop variation between channels in one product*5	Typ.	0.1			V
	Max.	0.3			
Dark current	Typ.	0.6	1.1	2.5	$\mu$ A
	Max.	1.8	3.3	7.5	
Crosstalk probability	-	7			%
Terminal capacitance	Ct	500	900	2000	pF
Gain	M	$2.5 \times 10^6$			-
Temperature coefficient of recommended reverse voltage	$\Delta T V_{op}$	34			mV/°C

\*3: Photon detection efficiency does not include crosstalk and afterpulses.

\*4: Refer to the data attached for each product.

\*5: The parameter is for the S14161 series (multichannel type)

**Photon detection efficiency vs. wavelength (typical example)**

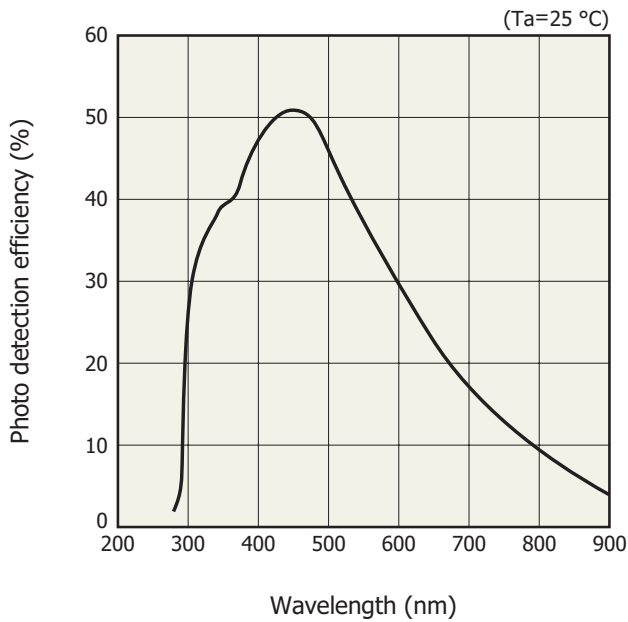

Photon detection efficiency does not include crosstalk and afterpulses.

**Overvoltage vs. gain, crosstalk probability, photon detection efficiency (typical example)**

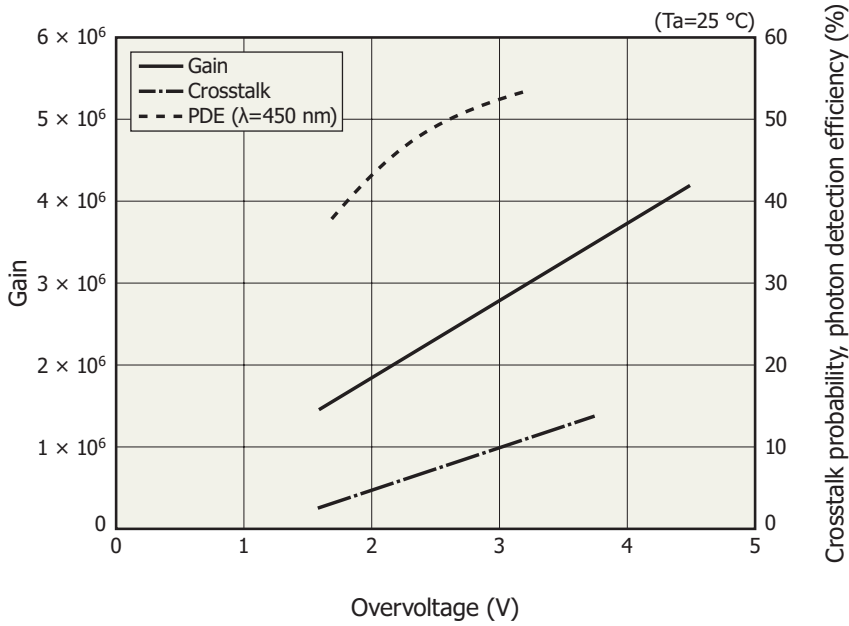

KAPDB0430EA

MPPC characteristics vary with the operating voltage. Although increasing the operating voltage improves the photon detection efficiency and time resolution, it also increases the dark count and crosstalk at the same time, so an optimum operating voltage must be selected to match the application.

**Coincidence resolution time vs. overvoltage (typical example)**

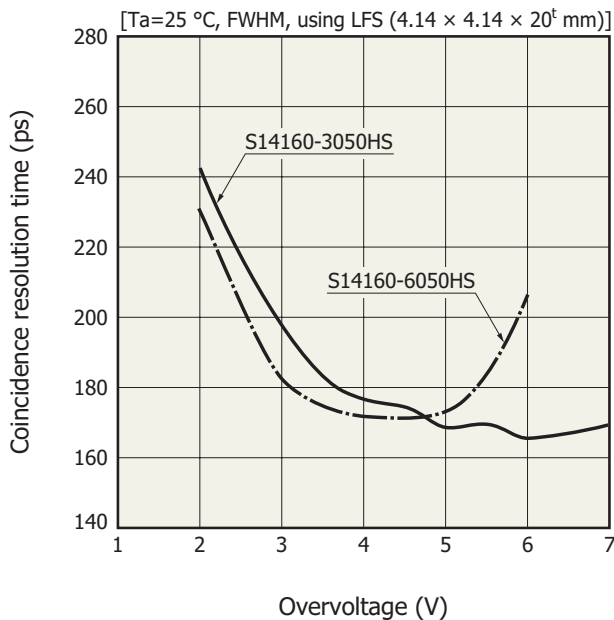

KAPDB0431EA

Dimensional outlines (unit: mm)

S14160-3050HS

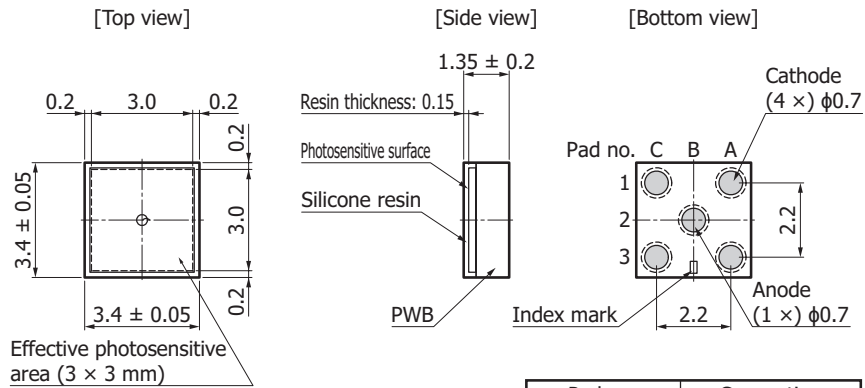

Tolerance unless otherwise noted: ±0.1

Pad no.	Connection
A1, A3, C1, C3	Cathode common
B2	Anode

KAPDA0195EA

S14160-4050HS

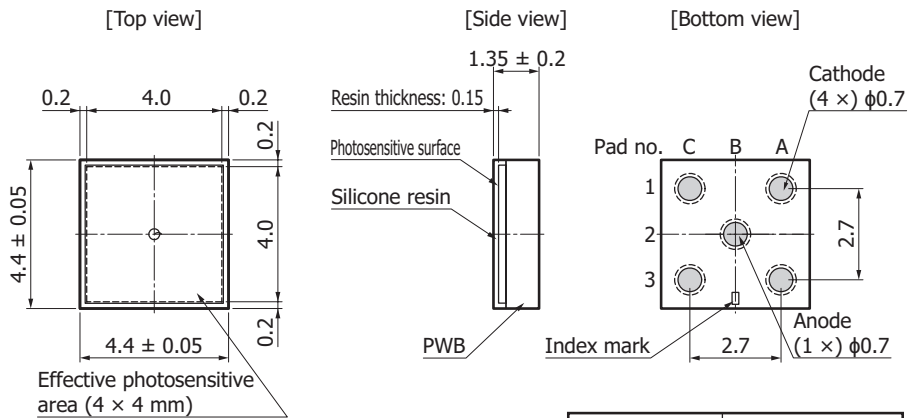

Tolerance unless otherwise noted: ±0.1

Pad no.	Connection
A1, A3, C1, C3	Cathode common
B2	Anode

KAPDA0196EA

S14160-6050HS

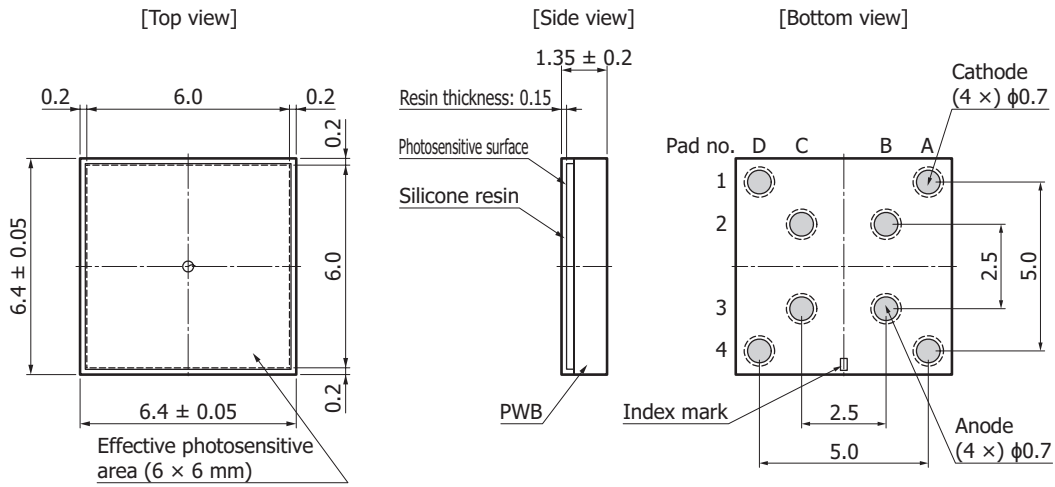

Tolerance unless otherwise noted: ±0.1

Pad no.	Connection
A1, A4, D1, D4	Cathode common
B2, B3, C2, C3	Anode common

KAPDA0197EA

S14161-3050HS-04

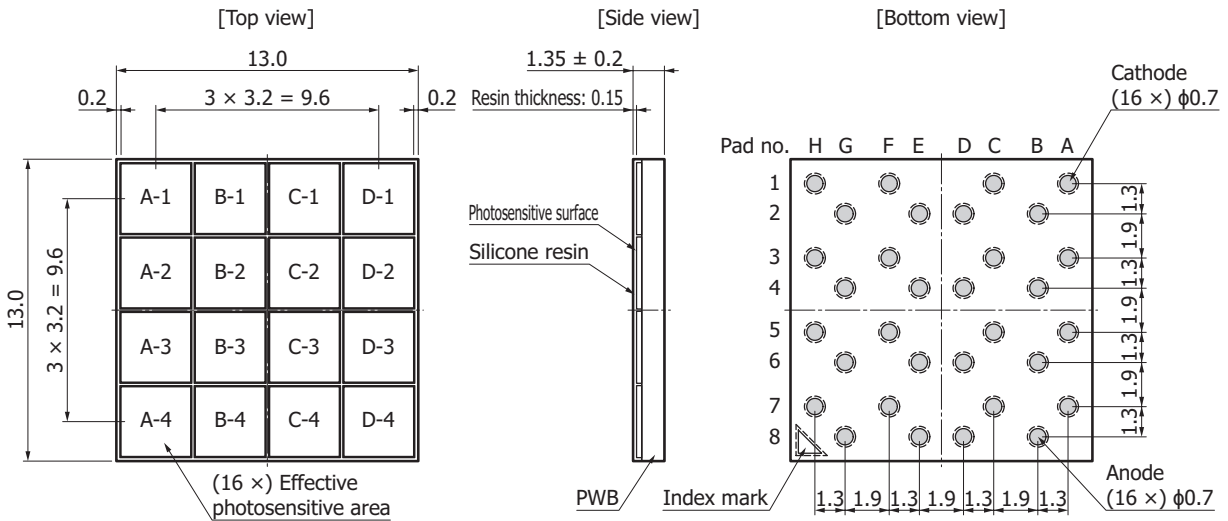

Tolerance unless otherwise noted: ±0.1

KAPDA0198EA

Pad no.	Connection	Pad no.	Connection	Pad no.	Connection	Pad no.	Connection	Pad no.	Connection	Pad no.	Connection	Pad no.	Connection	Pad no.	Connection
H1	A(D-1)	-	-	F1	A(C-1)	-	-	-	-	C1	K(B-1)	-	-	A1	K(A-1)
-	-	G2	K(D-1)	-	-	E2	K(C-1)	D2	A(B-1)	-	-	B2	A(A-1)	-	-
H3	A(D-2)	-	-	F3	A(C-2)	-	-	-	-	C3	K(B-2)	-	-	A3	K(A-2)
-	-	G4	K(D-2)	-	-	E4	K(C-2)	D4	A(B-2)	-	-	B4	A(A-2)	-	-
H5	A(D-3)	-	-	F5	A(C-3)	-	-	-	-	C5	K(B-3)	-	-	A5	K(A-3)
-	-	G6	K(D-3)	-	-	E6	K(C-3)	D6	A(B-3)	-	-	B6	A(A-3)	-	-
H7	A(D-4)	-	-	F7	A(C-4)	-	-	-	-	C7	K(B-4)	-	-	A7	K(A-4)
-	-	G8	K(D-4)	-	-	E8	K(C-4)	D8	A(B-4)	-	-	B8	A(A-4)	-	-

Note: A=Anode, K=Cathode

S14161-3050HS-08

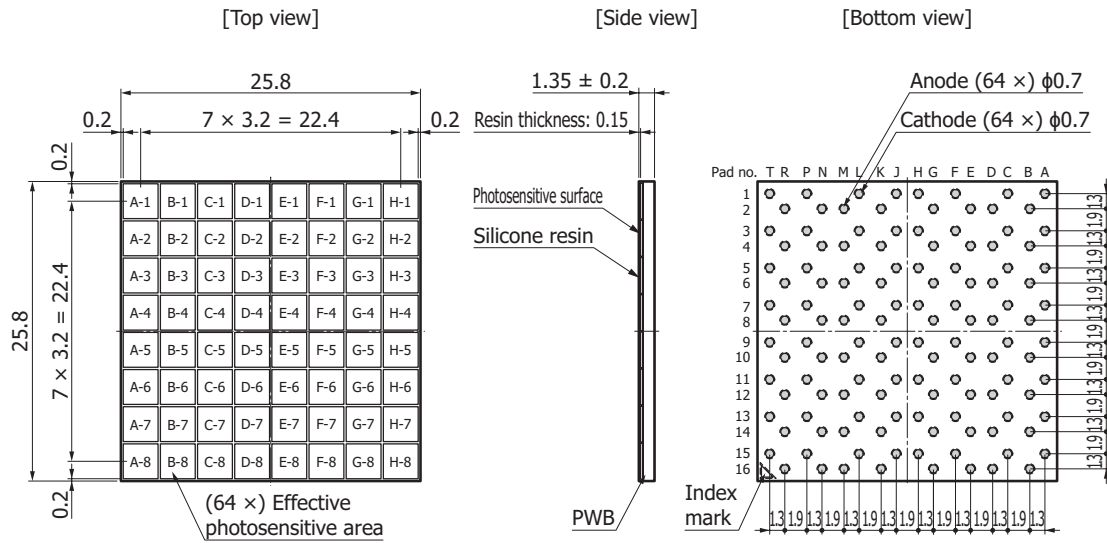

Tolerance unless otherwise noted: ±0.1

KAPDA0199EA

Pad no.	Connection	Pad no.	Connection	Pad no.	Connection	Pad no.	Connection	Pad no.	Connection	Pad no.	Connection	Pad no.	Connection	Pad no.	Connection
T1	A(H-1)	-	-	P1	A(G-1)	-	-	-	-	L1	K(F-1)	-	-	J1	K(E-1)
-	-	R2	K(H-1)	-	-	N2	K(G-1)	M2	A(F-1)	-	-	K2	A(E-1)	-	-
T3	A(H-2)	-	-	P3	A(G-2)	-	-	-	-	L3	K(F-2)	-	-	J3	K(E-2)
-	-	R4	K(H-2)	-	-	N4	K(G-2)	M4	A(F-2)	-	-	K4	A(E-2)	-	-
T5	A(H-3)	-	-	P5	A(G-3)	-	-	-	-	L5	K(F-3)	-	-	J5	K(E-3)
-	-	R6	K(H-3)	-	-	N6	K(G-3)	M6	A(F-3)	-	-	K6	A(E-3)	-	-
T7	A(H-4)	-	-	P7	A(G-4)	-	-	-	-	L7	K(F-4)	-	-	J7	K(E-4)
-	-	R8	K(H-4)	-	-	N8	K(G-4)	M8	A(F-4)	-	-	K8	A(E-4)	-	-
T9	A(H-5)	-	-	P9	A(G-5)	-	-	-	-	L9	K(F-5)	-	-	J9	K(E-5)
-	-	R10	K(H-5)	-	-	N10	K(G-5)	M10	A(F-5)	-	-	K10	A(E-5)	-	-
T11	A(H-6)	-	-	P11	A(G-6)	-	-	-	-	L11	K(F-6)	-	-	J11	K(E-6)
-	-	R12	K(H-6)	-	-	N12	K(G-6)	M12	A(F-6)	-	-	K12	A(E-6)	-	-
T13	A(H-7)	-	-	P13	A(G-7)	-	-	-	-	L13	K(F-7)	-	-	J13	K(E-7)
-	-	R14	K(H-7)	-	-	N14	K(G-7)	M14	A(F-7)	-	-	K14	A(E-7)	-	-
T15	A(H-8)	-	-	P15	A(G-8)	-	-	-	-	L15	K(F-8)	-	-	J15	K(E-8)
-	-	R16	K(H-8)	-	-	N16	K(G-8)	M16	A(F-8)	-	-	K16	A(E-8)	-	-

Pad no.	Connection	Pad no.	Connection	Pad no.	Connection	Pad no.	Connection	Pad no.	Connection	Pad no.	Connection	Pad no.	Connection	Pad no.	Connection
H1	A(D-1)	-	-	F1	A(C-1)	-	-	-	-	C1	K(B-1)	-	-	A1	K(A-1)
-	-	G2	K(D-1)	-	-	E2	K(C-1)	D2	A(B-1)	-	-	B2	A(A-1)	-	-
H3	A(D-2)	-	-	F3	A(C-2)	-	-	-	-	C3	K(B-2)	-	-	A3	K(A-2)
-	-	G4	K(D-2)	-	-	E4	K(C-2)	D4	A(B-2)	-	-	B4	A(A-2)	-	-
H5	A(D-3)	-	-	F5	A(C-3)	-	-	-	-	C5	K(B-3)	-	-	A5	K(A-3)
-	-	G6	K(D-3)	-	-	E6	K(C-3)	D6	A(B-3)	-	-	B6	A(A-3)	-	-
H7	A(D-4)	-	-	F7	A(C-4)	-	-	-	-	C7	K(B-4)	-	-	A7	K(A-4)
-	-	G8	K(D-4)	-	-	E8	K(C-4)	D8	A(B-4)	-	-	B8	A(A-4)	-	-
H9	A(D-5)	-	-	F9	A(C-5)	-	-	-	-	C9	K(B-5)	-	-	A9	K(A-5)
-	-	G10	K(D-5)	-	-	E10	K(C-5)	D10	A(B-5)	-	-	B10	A(A-5)	-	-
H11	A(D-6)	-	-	F11	A(C-6)	-	-	-	-	C11	K(B-6)	-	-	A11	K(A-6)
-	-	G12	K(D-6)	-	-	E12	K(C-6)	D12	A(B-6)	-	-	B12	A(A-6)	-	-
H13	A(D-7)	-	-	F13	A(C-7)	-	-	-	-	C13	K(B-7)	-	-	A13	K(A-7)
-	-	G14	K(D-7)	-	-	E14	K(C-7)	D14	A(B-7)	-	-	B14	A(A-7)	-	-
H15	A(D-8)	-	-	F15	A(C-8)	-	-	-	-	C15	K(B-8)	-	-	A15	K(A-8)
-	-	G16	K(D-8)	-	-	E16	K(C-8)	D16	A(B-8)	-	-	B16	A(A-8)	-	-

Note: A=Anode, K=Cathode

S14161-4050HS-06

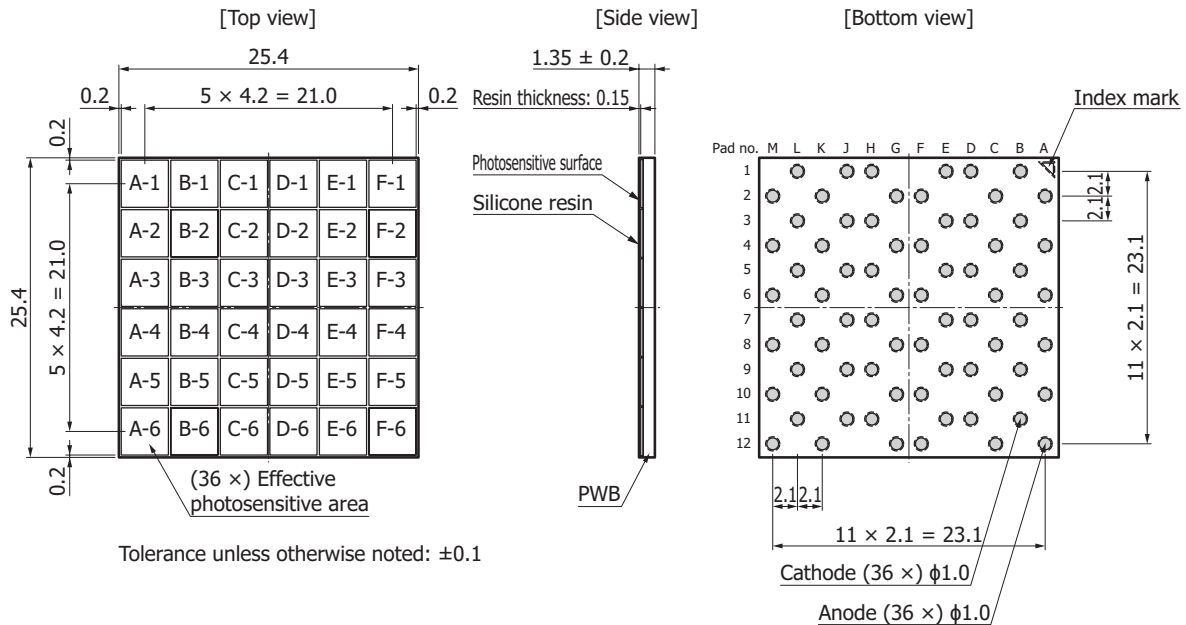

KAPDA0200EA

Pad no.	Connection	Pad no.	Connection	Pad no.	Connection	Pad no.	Connection	Pad no.	Connection	Pad no.	Connection
-	-	L1	A(F-1)	-	-	J1	A(E-1)	H1	K(D-1)	-	-
M2	K(F-1)	-	-	K2	K(E-1)	-	-	-	-	G2	A(D-1)
-	-	L3	A(F-2)	-	-	J3	A(E-2)	H3	K(D-2)	-	-
M4	K(F-2)	-	-	K4	K(E-2)	-	-	-	-	G4	A(D-2)
-	-	L5	A(F-3)	-	-	J5	A(E-3)	H5	K(D-3)	-	-
M6	K(F-3)	-	-	K6	K(E-3)	-	-	-	-	G6	A(D-3)
-	-	L7	A(F-4)	-	-	J7	A(E-4)	H7	K(D-4)	-	-
M8	K(F-4)	-	-	K8	K(E-4)	-	-	-	-	G8	A(D-4)
-	-	L9	A(F-5)	-	-	J9	A(E-5)	H9	K(D-5)	-	-
M10	K(F-5)	-	-	K10	K(E-5)	-	-	-	-	G10	A(D-5)
-	-	L11	A(F-6)	-	-	J11	A(E-6)	H11	K(D-6)	-	-
M12	K(F-6)	-	-	K12	K(E-6)	-	-	-	-	G12	A(D-6)

Pad no.	Connection	Pad no.	Connection	Pad no.	Connection	Pad no.	Connection	Pad no.	Connection	Pad no.	Connection
-	-	E1	A(C-1)	D1	K(B-1)	-	-	B1	K(A-1)	-	-
F2	K(C-1)	-	-	-	-	C2	A(B-1)	-	-	A2	A(A-1)
-	-	E3	A(C-2)	D3	K(B-2)	-	-	B3	K(A-2)	-	-
F4	K(C-2)	-	-	-	-	C4	A(B-2)	-	-	A4	A(A-2)
-	-	E5	A(C-3)	D5	K(B-3)	-	-	B5	K(A-3)	-	-
F6	K(C-3)	-	-	-	-	C6	A(B-3)	-	-	A6	A(A-3)
-	-	E7	A(C-4)	D7	K(B-4)	-	-	B7	K(A-4)	-	-
F8	K(C-4)	-	-	-	-	C8	A(B-4)	-	-	A8	A(A-4)
-	-	E9	A(C-5)	D9	K(B-5)	-	-	B9	K(A-5)	-	-
F10	K(C-5)	-	-	-	-	C10	A(B-5)	-	-	A10	A(A-5)
-	-	E11	A(C-6)	D11	K(B-6)	-	-	B11	K(A-6)	-	-
F12	K(C-6)	-	-	-	-	C12	A(B-6)	-	-	A12	A(A-6)

Note: A=Anode, K=Cathode

S14161-6050HS-04

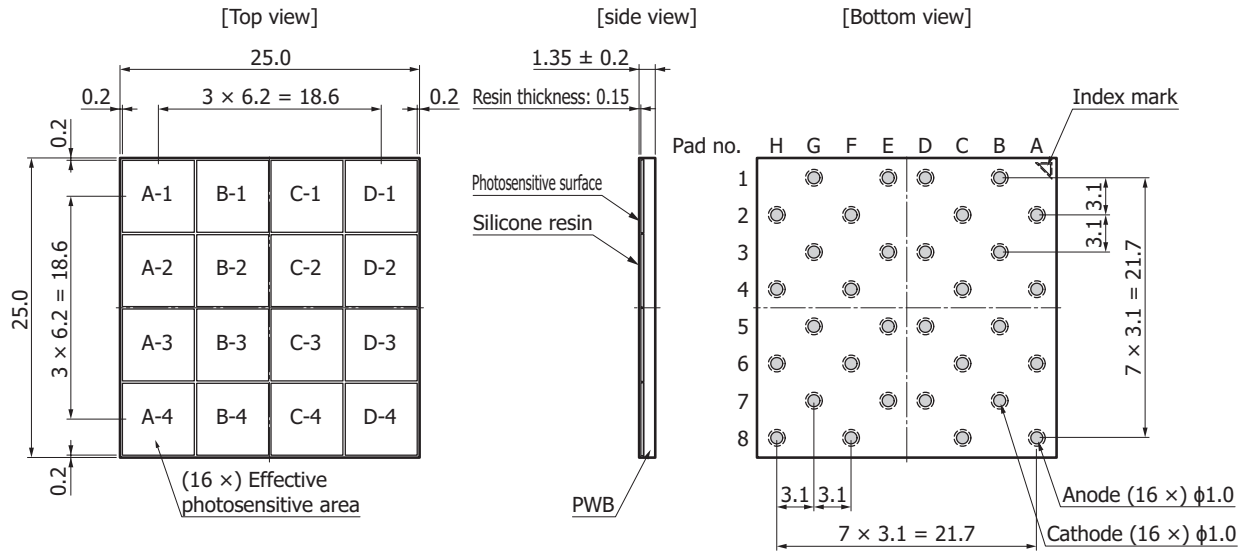

Tolerance unless otherwise noted: ±0.1

KAPDA0201EA

Pad no.	Connection	Pad no.	Connection	Pad no.	Connection	Pad no.	Connection	Pad no.	Connection	Pad no.	Connection	Pad no.	Connection	Pad no.	Connection
-	-	G1	A(D-1)	-	-	E1	A(C-1)	D1	K(B-1)	-	-	B1	K(A-1)	-	-
H2	K(D-1)	-	-	F2	K(C-1)	-	-	-	-	C2	A(B-1)	-	-	A2	A(A-1)
-	-	G3	A(D-2)	-	-	E3	A(C-2)	D3	K(B-2)	-	-	B3	K(A-2)	-	-
H4	K(D-2)	-	-	F4	K(C-2)	-	-	-	-	C4	A(B-2)	-	-	A4	A(A-2)
-	-	G5	A(D-3)	-	-	E5	A(C-3)	D5	K(B-3)	-	-	B5	K(A-3)	-	-
H6	K(D-3)	-	-	F6	K(C-3)	-	-	-	-	C6	A(B-3)	-	-	A6	A(A-3)
-	-	G7	A(D-4)	-	-	E7	A(C-4)	D7	K(B-4)	-	-	B7	K(A-4)	-	-
H8	K(D-4)	-	-	F8	K(C-4)	-	-	-	-	C8	A(B-4)	-	-	A8	A(A-4)

Note: A=Anode, K=Cathode



Recommended land pattern (unit: mm)

S14160-3050HS

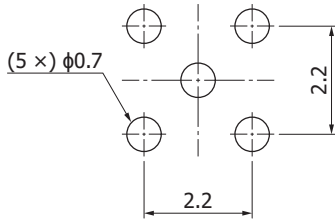

KAPDC0108EA

S14160-4050HS

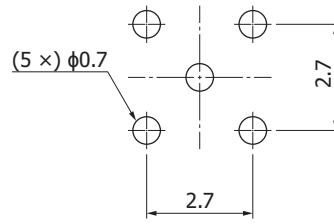

KAPDC0109EA

S14160-6050HS

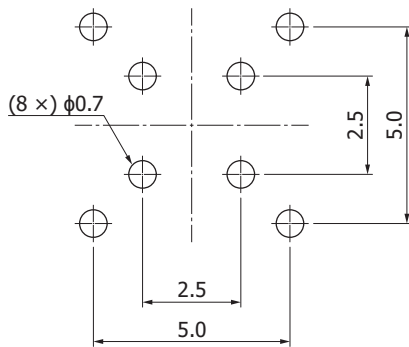

KAPDC0110EA

S14161-3050HS-04

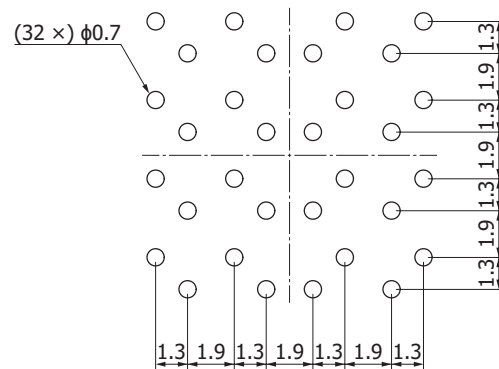

KAPDC0111EA

S14161-3050HS-08

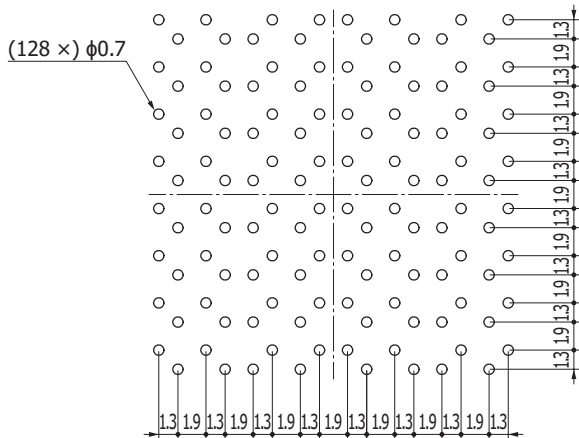

KAPDC0112EA

S14161-4050HS-06

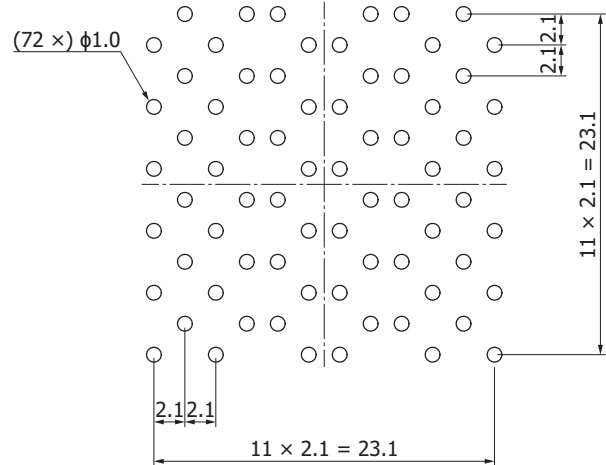

KAPDC0113EA

S14161-6050HS-04

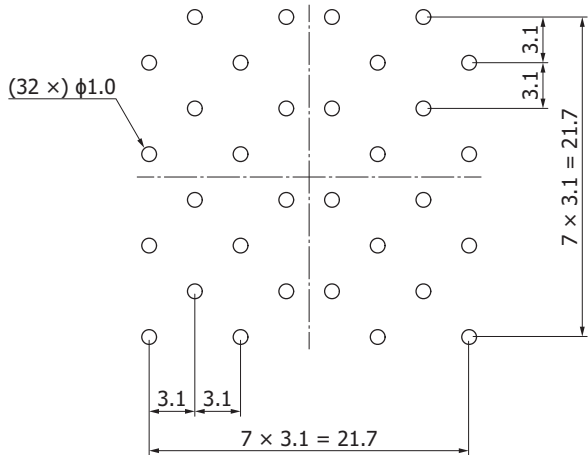

KAPDC0114EA

### Recommended reflow soldering conditions

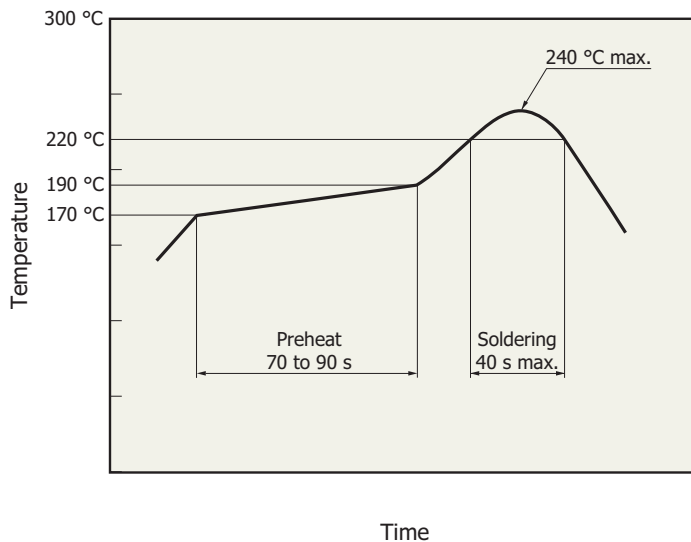

KPIC80171EA

- This surface mount type package product supports lead-free soldering. After unpacking, store it in an environment at a temperature of 25 °C or less and a humidity of 60% or less, and perform soldering within 24 hours.
- The effect that the product is subject to during reflow soldering varies depending on the circuit board and reflow furnace that are used. Before actual reflow soldering, check for any problems by testing out the reflow soldering methods in advance.
- When three or more months have passed or if the packing bag has not been stored in an environment described above, perform baking. For the baking method, see the related information "Surface mount type products" precautions.

## ⚠ Precautions

- If necessary, incorporate appropriate protective circuits in power supplies, devices, and measuring instruments to prevent overvoltage and overcurrent.

## ⚠ Related information

[www.hamamatsu.com/sp/ssd/doc\\_en.html](http://www.hamamatsu.com/sp/ssd/doc_en.html)

### ■ Precautions

- Disclaimer
- Surface mount type products

### ■ Technical information

- MPPC

MPPC is a registered trademark of Hamamatsu Photonics K.K.  
Information described in this material is current as of June 2020.

Product specifications are subject to change without prior notice due to improvements or other reasons. This document has been carefully prepared and the information contained is believed to be accurate. In rare cases, however, there may be inaccuracies such as text errors. Before using these products, always contact us for the delivery specification sheet to check the latest specifications.

The product warranty is valid for one year after delivery and is limited to product repair or replacement for defects discovered and reported to us within that one year period. However, even if within the warranty period we accept absolutely no liability for any loss caused by natural disasters or improper product use. Copying or reprinting the contents described in this material in whole or in part is prohibited without our prior permission.

# HAMAMATSU

[www.hamamatsu.com](http://www.hamamatsu.com)

HAMAMATSU PHOTONICS K.K., Solid State Division

1126-1 Ichino-cho, Higashi-ku, Hamamatsu City, 435-8558 Japan, Telephone: (81)53-434-3311, Fax: (81)53-434-5184

U.S.A.: Hamamatsu Corporation, 360 Foothill Road, Bridgewater, N.J. 08807, U.S.A., Telephone: (1)908-231-0960, Fax: (1)908-231-1218, E-mail: [usa@hamamatsu.com](mailto:usa@hamamatsu.com)

Germany: Hamamatsu Photonics Deutschland GmbH, Arzbergerstr. 10, D-82211 Herrsching am Ammersee, Germany, Telephone: (49)8152-375-0, Fax: (49)8152-265-8, E-mail: [info@hamamatsu.de](mailto:info@hamamatsu.de)

France: Hamamatsu Photonics France S.A.R.L.: 19, Rue du Saule Trapu, Parc du Moulin de Massy, 91882 Massy Cedex, France, Telephone: (33)1 69 53 71 00, Fax: (33)1 69 53 71 10, E-mail: [infos@hamamatsu.fr](mailto:infos@hamamatsu.fr)

United Kingdom: Hamamatsu Photonics UK Limited: 2 Howard Court, 10 Tewin Road, Welwyn Garden City, Hertfordshire AL7 1BW, UK, Telephone: (44)1707-294888, Fax: (44)1707-325777, E-mail: [info@hamamatsu.co.uk](mailto:info@hamamatsu.co.uk)

North Europe: Hamamatsu Photonics Norden AB: Torshamnsgatan 35 16440 Kista, Sweden, Telephone: (46)8-509 031 00, Fax: (46)8-509 031 01, E-mail: [info@hamamatsu.se](mailto:info@hamamatsu.se)

Italy: Hamamatsu Photonics Italia S.r.l.: Strada della Moia, 1 int. 6, 20020 Arese (Milano), Italy, Telephone: (39)02-93 58 17 33, Fax: (39)02-93 58 17 41, E-mail: [info@hamamatsu.it](mailto:info@hamamatsu.it)

China: Hamamatsu Photonics (China) Co., Ltd.: 1201 Tower B, Jiaming Center, 27 Dongsanhuan Beilu, Chaoyang District, 100020 Beijing, P.R.China, Telephone: (86)10-6586-6006, Fax: (86)10-6586-2866, E-mail: [hpc@hamamatsu.com.cn](mailto:hpc@hamamatsu.com.cn)

Taiwan: Hamamatsu Photonics Taiwan Co., Ltd.: 8F-3, No. 158, Section2, Gongdao 5th Road, East District, Hsinchu, 300, Taiwan R.O.C. Telephone: (886)3-659-0080, Fax: (886)3-659-0081, E-mail: [info@hamamatsu.com.tw](mailto:info@hamamatsu.com.tw)