

S13360 series

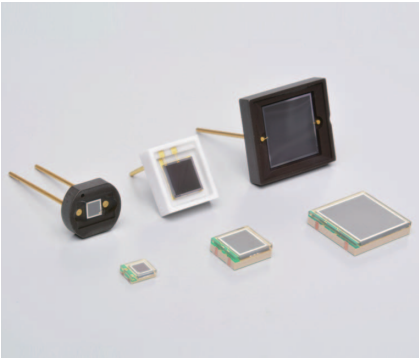

MPPCs for precision measurement

MPPC is a type of device called SiPM (silicon photomultiplier). It is a new type of photon counting device that consists of multiple Geiger mode APD (avalanche photodiode) pixels. It is an opto-semiconductor with outstanding photon counting capability and low operating voltage and is immune to the effects of magnetic fields.

The S13360 series are MPPCs for precision measurement. The MPPCs inherit the superb low afterpulse characteristics of previous products and further provide lower crosstalk and lower dark count. They are suitable for precision measurement, such as flow cytometry, DNA sequencer, laser microscope, and fluorescence measurement, that requires low noise characteristics.

Features

- **Reduced crosstalk and dark count (compared to previous products)**
- **Outstanding photon counting capability (outstanding photon detection efficiency versus numbers of incident photons)**
- **Compact**
- **Operates at room temperature**
- **Low voltage ($V_{BR}=53\text{ V typ.}$) operation**
- **High gain: 10^5 to 10^6**
- **Excellent time resolution**
- **Immune to the effects of magnetic fields**
- **Operates with simple readout circuit**
- **MPPC module also available (sold separately)**

Applications

- **Fluorescence measurement**
- **Laser microscopes**
- **Flow cytometry**
- **DNA sequencers**
- **Environmental analysis**
- **Various academic research**

Lower noise

When an MPPC detects photons, the output may contain spurious pulses, namely afterpulse and crosstalk, that are separate from the output pulses of the incident photons. Afterpulses are output later than the timing at which the incident light is received. Crosstalk is output from other pixels at the same time as the detection of light.

Previous products achieved lower afterpulse through the improvement of material and wafer process technology, but with the S13360 series, low crosstalk has been achieved in addition to low afterpulse.

☑ Pulse waveform comparison (typical example)

Previous product

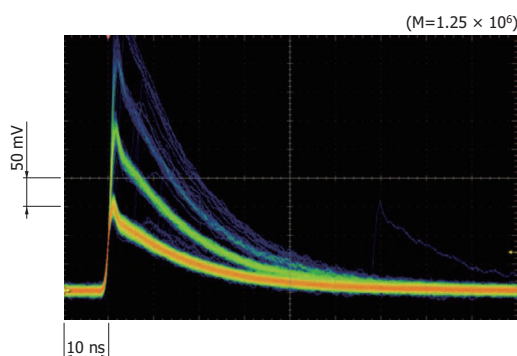

Improved product (reference data: S13360-3050CS series)

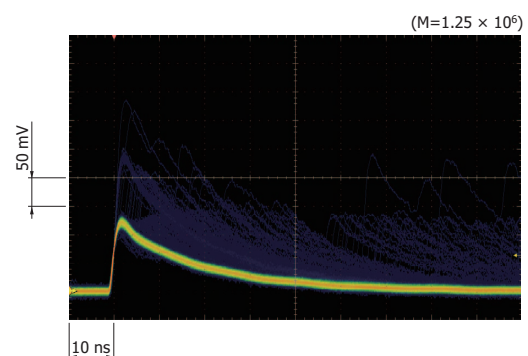

Selection guide

Type no.	Pixel pitch (μm)	Effective photosensitive area (mm)	Number of pixels	Package	Fill factor (%)
S13360-1325CS	25	1.3 × 1.3	2668	Ceramic	47
S13360-1325PE				Surface mount type	
S13360-3025CS		3.0 × 3.0	14400	Ceramic	
S13360-3025PE				Surface mount type	
S13360-6025CS		6.0 × 6.0	57600	Ceramic	
S13360-6025PE				Surface mount type	
S13360-1350CS	50	1.3 × 1.3	667	Ceramic	74
S13360-1350PE				Surface mount type	
S13360-3050CS		3.0 × 3.0	3600	Ceramic	
S13360-3050PE				Surface mount type	
S13360-6050CS		6.0 × 6.0	14400	Ceramic	
S13360-6050PE				Surface mount type	
S13360-1375CS	75	1.3 × 1.3	285	Ceramic	82
S13360-1375PE				Surface mount type	
S13360-3075CS		3.0 × 3.0	1600	Ceramic	
S13360-3075PE				Surface mount type	
S13360-6075CS		6.0 × 6.0	6400	Ceramic	
S13360-6075PE				Surface mount type	

Structure / Absolute maximum ratings

Type no. (package)	Window material	Refractive index of window material	Absolute maximum ratings			
			Operating temperature* ¹ Topr (°C)	Storage temperature* ¹ Tstg (°C)	Soldering conditions	Reflow soldering conditions* ² Tsol
S13360-****CS (ceramic)	Silicone resin	1.41	-20 to +60	-20 to +80	350 °C or less, once, within 3 seconds* ³	-
S13360-****PE (surface mount type)	Epoxy resin	1.55			-	Peak temperature: 240 °C, twice (see P.11)

*1: No condensation

*2: JEDEC level 5a

*3: Separate by at least 1 mm from the lead root.

Note: Exceeding the absolute maximum ratings even momentarily may cause a drop in product quality. Always be sure to use the product within the absolute maximum ratings.

Electrical and optical characteristics (Typ. Ta=25 °C, unless otherwise noted)

Type no.	Measurement conditions	Spectral response range λ (nm)	Peak sensitivity wavelength λ_p (nm)	Photon detection efficiency PDE*4 $\lambda=\lambda_p$ (%)	Dark count*5		Terminal capacitance Ct (pF)	Gain M	Break-down voltage VBR (V)	Crosstalk probability (%)	Recommended operating voltage Vop (V)	Temperature coefficient at recommended operating voltage $\Delta TVop$ (mV/°C)
					Typ. (kcps)	Max. (kcps)						
S13360-1325CS	Vover =5 V	270 to 900	450	25	70	210	60	7.0×10^5	53 ± 5	1	VBR + 5	54
S13360-1325PE		320 to 900										
S13360-3025CS		270 to 900			400	1200	320					
S13360-3025PE		320 to 900										
S13360-6025CS		270 to 900			1600	5000	1280					
S13360-6025PE		320 to 900										
S13360-1350CS	Vover =3 V	270 to 900		40	90	270	60	1.7×10^6	53 ± 5	3	VBR + 3	
S13360-1350PE		320 to 900										
S13360-3050CS		270 to 900			500	1500	320					
S13360-3050PE		320 to 900										
S13360-6050CS		270 to 900			2000	6000	1280					
S13360-6050PE		320 to 900										
S13360-1375CS	Vover =3 V	270 to 900	50	90	270	60	4.0×10^6	4.0×10^6	7	VBR + 3		
S13360-1375PE		320 to 900										
S13360-3075CS		270 to 900		500	1500	320						
S13360-3075PE		320 to 900										
S13360-6075CS		270 to 900		2000	6000	1280						
S13360-6075PE		320 to 900										

*4: Photon detection efficiency does not include crosstalk or afterpulses.

*5: Threshold=0.5 p.e.

Note: The above characteristics were measured at the operating voltage that yields the listed gain. (See the data attached to each product.)

Connection example

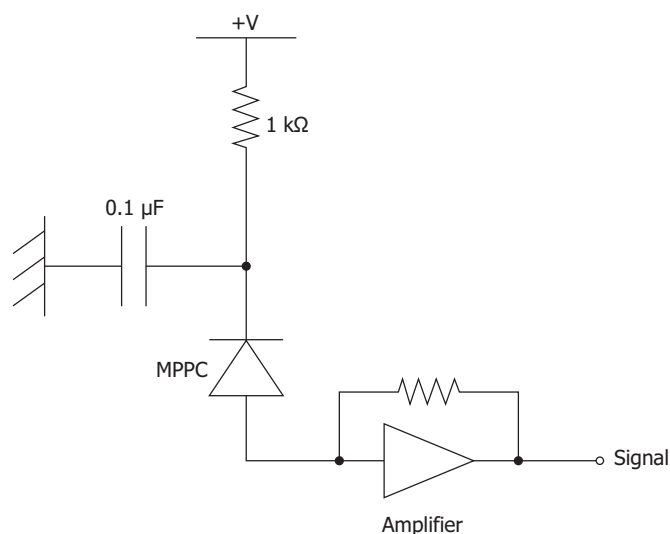

KAPDC0024EB

Photon detection efficiency vs. wavelength (typical example)

Pixel pitch: 25 μm

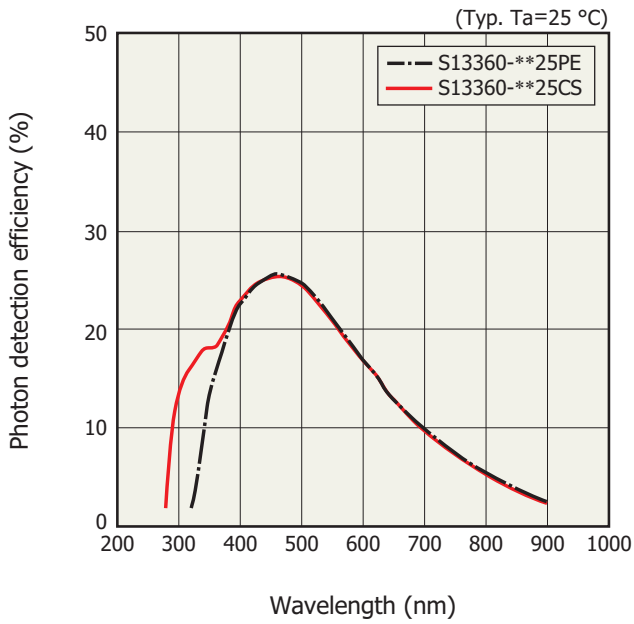

KAPDB0321EA

Pixel pitch: 50 μm

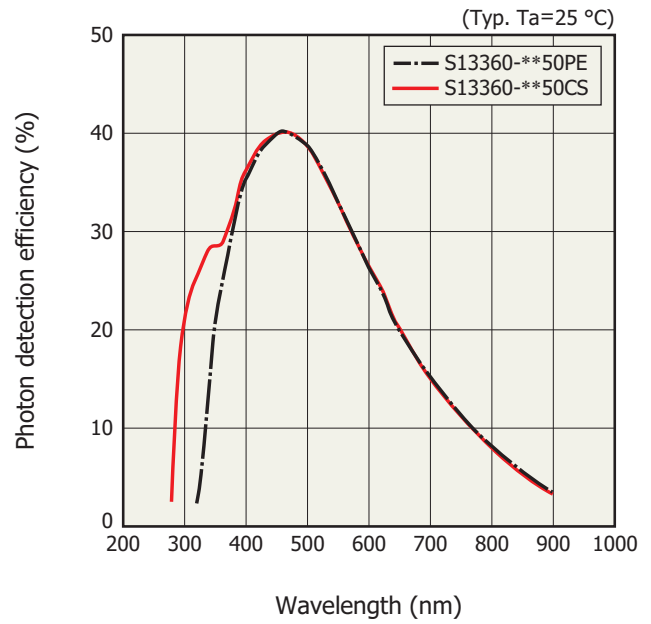

KAPDB0322EA

Pixel pitch: 75 μm

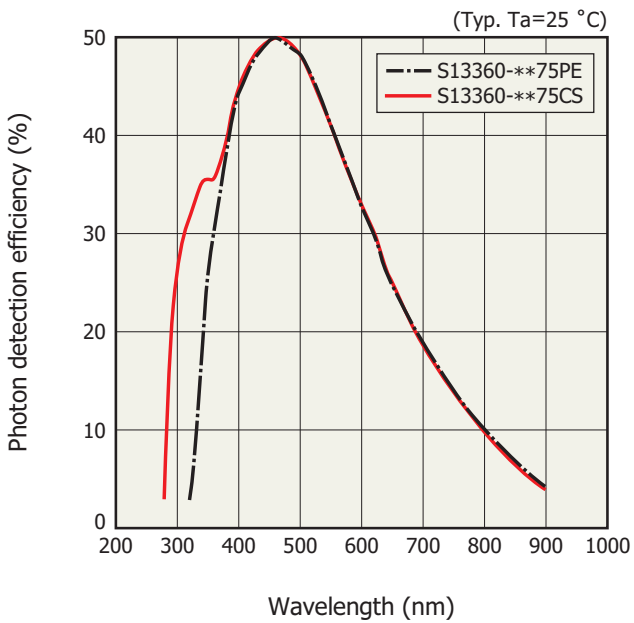

KAPDB0325EA

Photon detection efficiency does not include crosstalk or afterpulses.

Overvoltage specifications of gain, crosstalk probability, photon detection efficiency (typical example)

Pixel pitch: 25 μm

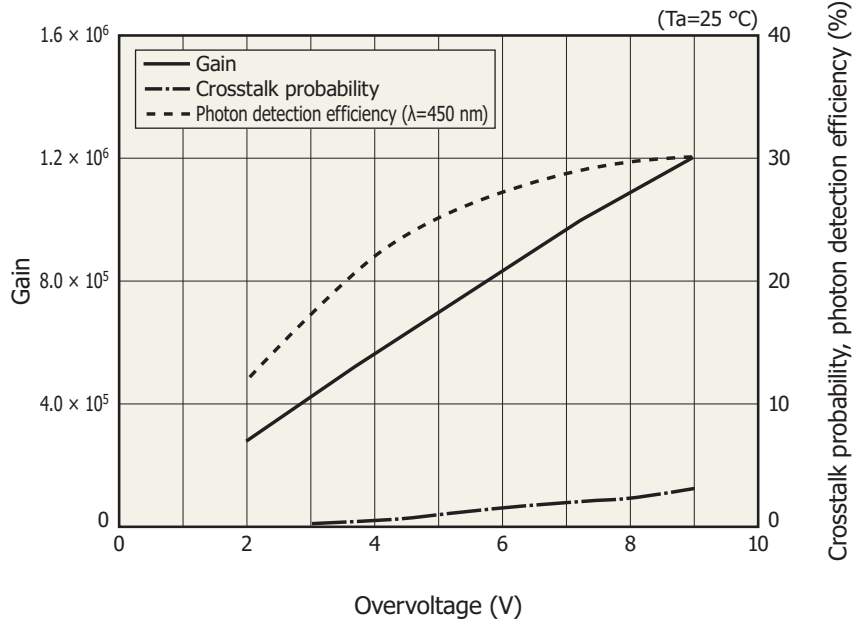

KAPD80323EA

Pixel pitch: 50 μm

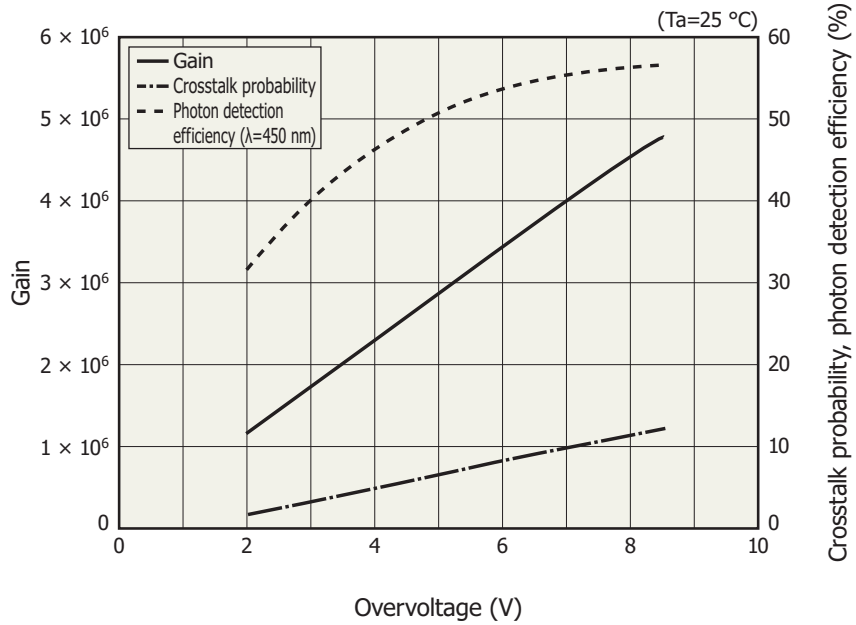

KAPD80324EA

Pixel pitch: 75 μm

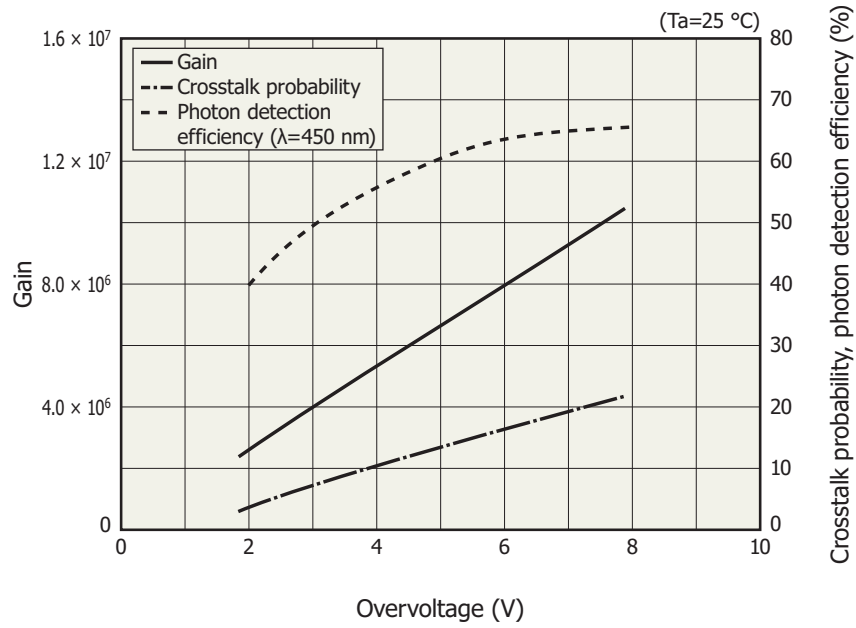

KAPD0326EA

MPPC characteristics vary with the operating voltage. Although increasing the operating voltage improves the photon detection efficiency and time resolution, it also increases the dark count and crosstalk at the same time, so an optimum operating voltage must be selected to match the application.

Dimensional outlines (unit: mm)

S13360-1325CS/-1350CS/-1375CS

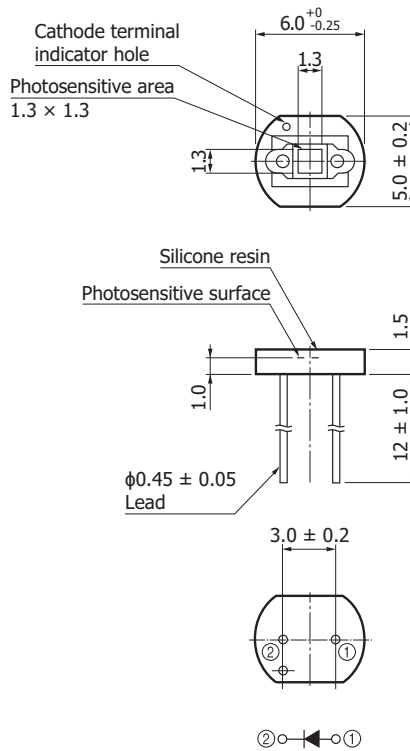

Lead material: Fe-Ni-Co alloy
 Lead processing: Au plating
 Tolerance unless otherwise noted: ±0.2
 Chip position accuracy:
 X, Y ≤ ±0.25 with respect to package center
 The coating resin may extend a maximum of
 0.1 mm above the upper surface of the package.

KAPDA0155EA

S13360-3025CS/-3050CS/-3075CS

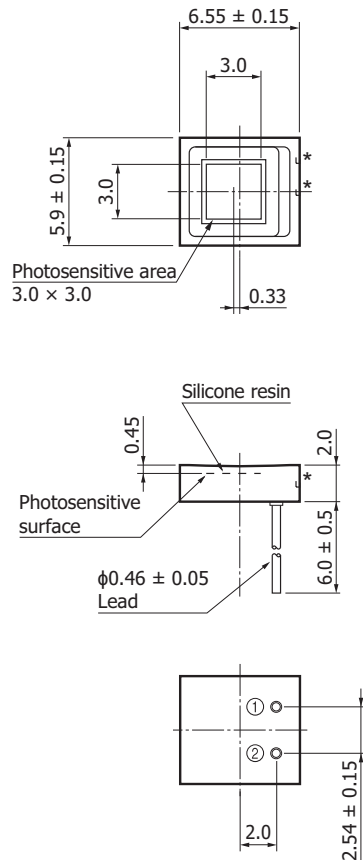

Lead material: Oxygen-free copper
 Lead processing: Au plating
 Tolerance unless otherwise noted: ±0.2
 Chip position accuracy:
 with respect to package center
 $-0.25 \leq X \leq +0.25$
 $-0.53 \leq Y \leq -0.13$
 The coating resin may extend a maximum of
 0.1 mm above the upper surface of the package.

* Metal electrodes connecting to the internal electrodes are exposed on the sides of the ceramic package. To avoid short circuits, never allow other conductors to come in contact with these metal electrodes.

KAPDA0156EA

S13360-6025CS/-6050CS/-6075CS

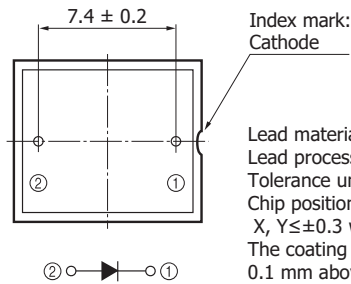
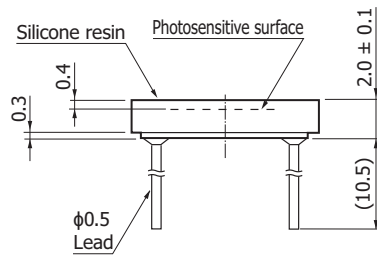
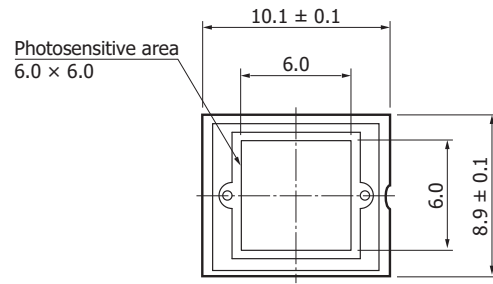

Lead material: Fe-Ni-Co alloy
 Lead processing: Au plating
 Tolerance unless otherwise noted: ±0.2
 Chip position accuracy:
 X, Y ≤ ±0.3 with respect to package center
 The coating resin may extend a maximum of
 0.1 mm above the upper surface of the package.

KAPDA0157EC

S13360-1325PE/-1350PE/-1375PE

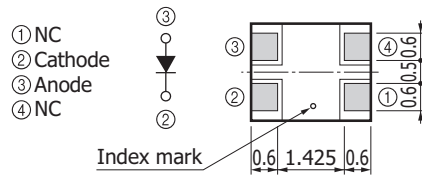
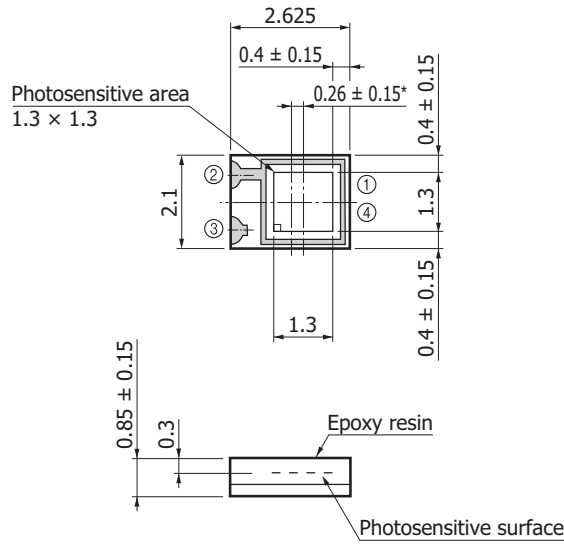

Tolerance unless otherwise noted: ±0.1

* Distance from chip center to package center

KAPDA0158EA

S13360-3025PE/-3050PE/-3075PE

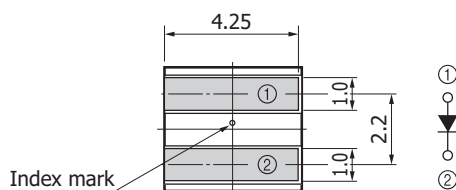
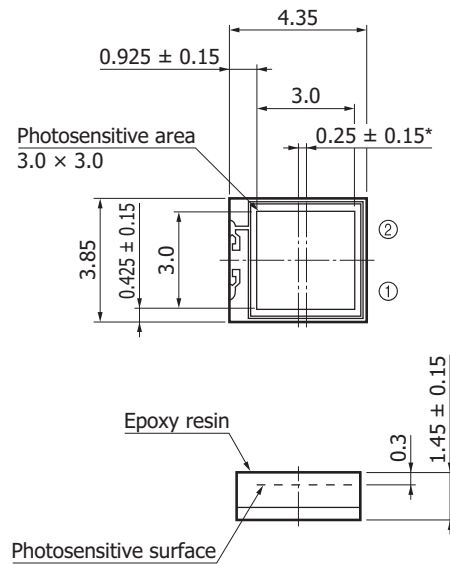

Tolerance unless otherwise noted: ±0.1

* Distance from chip center to package center

KAPDA0159EA

S13360-6025PE/-6050PE/-6075PE

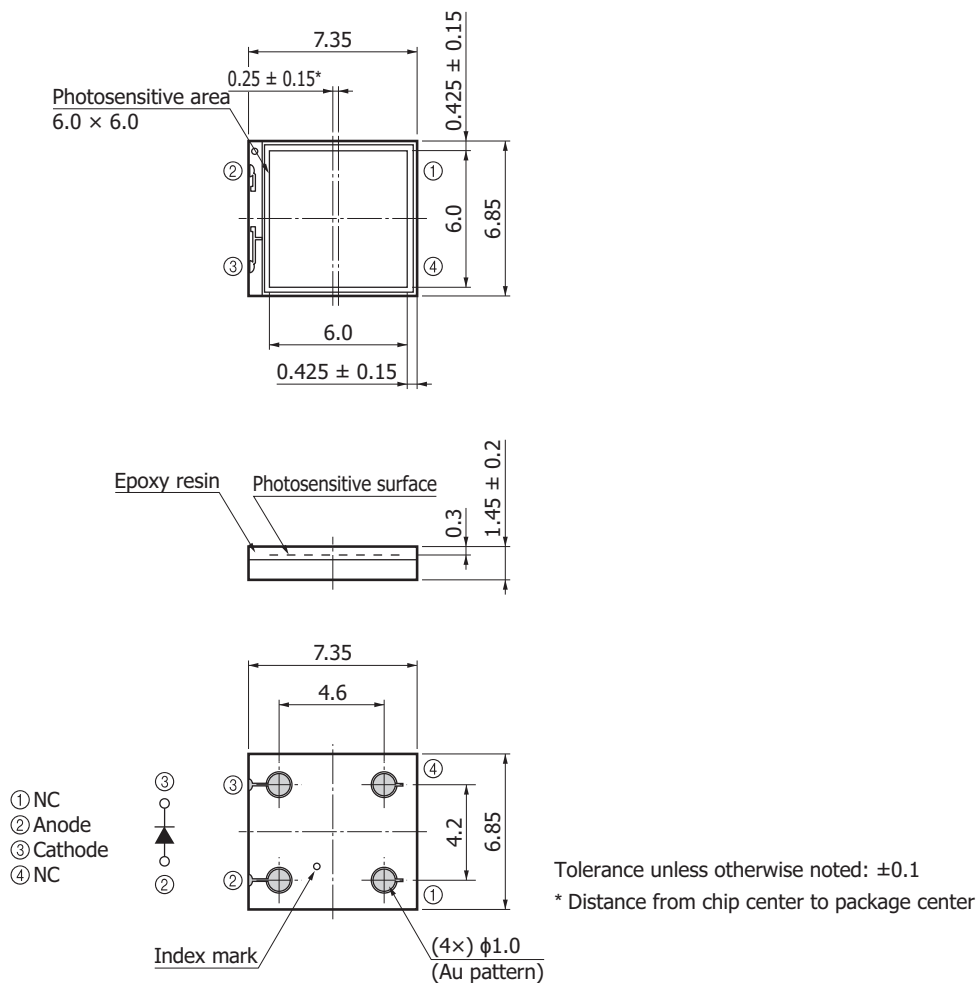

KAPDA0153EA

Recommended land pattern (Unit: mm)

S13360-1325PE/-1350PE/-1375PE

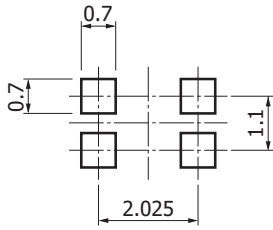

KAPDC0056EA

S13360-3025PE/-3050PE/-3075PE

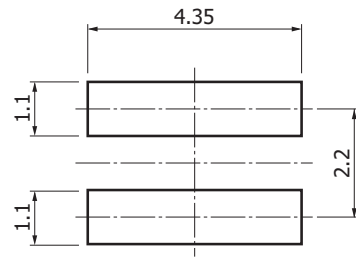

KAPDC0057EA

S13360-6025PE/-6050PE/-6075PE

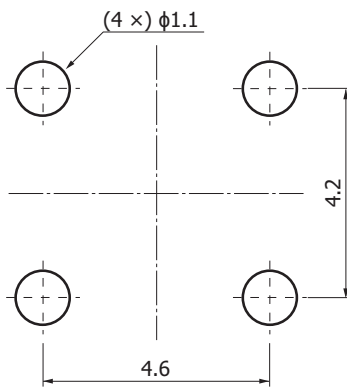

KAPDC0057EA

Temperature profile measurement example using our experimental hot-air reflow oven (S13360-1350PE)

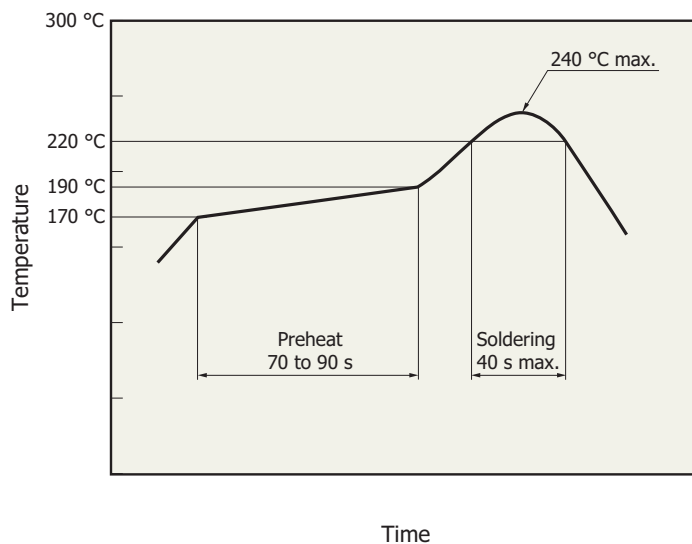

KPICB0171EA

- This surface mount type package product supports lead-free soldering. After unpacking, store it in an environment at a temperature of 25 °C or less and a humidity of 60% or less, and perform soldering within 24 hours.
- The effect that the product is subject to during reflow soldering varies depending on the circuit board and reflow furnace that are used. Before actual reflow soldering, check for any problems by testing out the reflow soldering methods in advance.

Precautions

- If necessary, incorporate appropriate protective circuits in power supplies, devices, and measuring instruments to prevent overvoltage and overcurrent.

Related information

www.hamamatsu.com/sp/ssd/doc_en.html

■ Precautions

- Disclaimer
- Metal, ceramic, plastic package products
- Surface mount type products

MPPC is a registered trademark of Hamamatsu Photonics K.K.

Information described in this material is current as of August 2016.

Product specifications are subject to change without prior notice due to improvements or other reasons. This document has been carefully prepared and the information contained is believed to be accurate. In rare cases, however, there may be inaccuracies such as text errors. Before using these products, always contact us for the delivery specification sheet to check the latest specifications.

The product warranty is valid for one year after delivery and is limited to product repair or replacement for defects discovered and reported to us within that one year period. However, even if within the warranty period we accept absolutely no liability for any loss caused by natural disasters or improper product use. Copying or reprinting the contents described in this material in whole or in part is prohibited without our prior permission.

HAMAMATSUwww.hamamatsu.com

HAMAMATSU PHOTONICS K.K., Solid State Division

1126-1 Ichino-cho, Higashi-ku, Hamamatsu City, 435-8558 Japan, Telephone: (81) 53-434-3311, Fax: (81) 53-434-5184

U.S.A.: Hamamatsu Corporation: 360 Foothill Road, Bridgewater, N.J. 08807, U.S.A., Telephone: (1) 908-231-0960, Fax: (1) 908-231-1218

Germany: Hamamatsu Photonics Deutschland GmbH: Arzbergerstr. 10, D-82211 Herrsching am Ammersee, Germany, Telephone: (49) 8152-375-0, Fax: (49) 8152-265-8

France: Hamamatsu Photonics France S.A.R.L.: 19, Rue du Saule Trapu, Parc du Moulin de Massy, 91882 Massy Cedex, France, Telephone: 33-(1) 69 53 71 00, Fax: 33-(1) 69 53 71 10

United Kingdom: Hamamatsu Photonics UK Limited: 2 Howard Court, 10 Tewin Road, Welwyn Garden City, Hertfordshire AL7 1BW, United Kingdom, Telephone: (44) 1707-294888, Fax: (44) 1707-325777

North Europe: Hamamatsu Photonics Norden AB: Torshamnsgatan 35 16440 Kista, Sweden, Telephone: (46) 8-509-031-00, Fax: (46) 8-509-031-01

Italy: Hamamatsu Photonics Italia S.r.l.: Strada della Moia, 1 int. 6, 20020 Arese (Milano), Italy, Telephone: (39) 02-93581733, Fax: (39) 02-93581741

China: Hamamatsu Photonics (China) Co., Ltd.: B1201, Jiaming Center, No.27 Dongsanhuan Beilu, Chaoyang District, Beijing 100020, China, Telephone: (86) 10-6586-6006, Fax: (86) 10-6586-2866