

16-element Si photodiode arrays

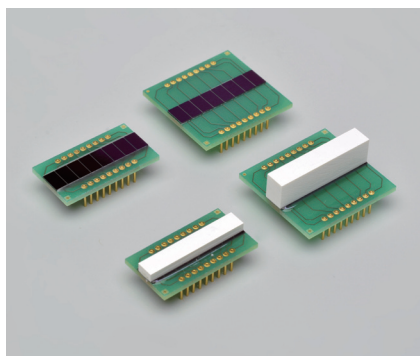

S12858/S12859 series

Back-illuminated photodiode arrays for X-ray non-destructive inspection (element pitch: 1.17 mm)

The S12858/S12859 series is a back-illuminated type 16-element photodiode array specifically designed for non-destructive X-ray inspection. These are modified versions of our previous products (S11212 series: 1.575 mm pitch). The pitch has been changed to 1.17 mm. The back-illuminated photodiode array is also simple to handle and easily couples to scintillators without having to worry about wire damage because there are no bonding wires and photosensitive areas on the back side.

Features

- Spectral response range: 340 to 1100 nm
- Element size: 0.77 (W) × 2.5 (H) mm/one element
- Element pitch: 1.17 mm (× 16 pixels)
- Mounted on two kinds of board size:
19.0 (W) × 10.2 (H) mm, 19.0 (W) × 18.0 (H) mm
- Long and narrow format by multiple arrays
- Supports dual energy imaging
(When used in an upper and lower two-layer combination. See P.8.)

Applications

- X-ray non-destructive inspection, etc.

Selection guide

Type no.	Number of elements	Element pitch (mm)	Element size W × H (mm)	Board size W × H (mm)	Scintillator			Application example
					Type	Afterglow*1	Crosstalk*1	
S12858-021	16	1.17	0.77 × 2.5	19.0 × 10.2	None*2	-	-	General photometry
S12859-021				19.0 × 18.0				
S12858-122				19.0 × 10.2	CsI(Tl)	Large	Low	X-ray non-destructive inspection of slow-moving objects (baggage inspection, etc.)
S12859-122				19.0 × 18.0				
S12858-324				19.0 × 10.2	GOS ceramic	Small	Low	X-ray non-destructive inspection of fast-moving objects (baggage inspection, etc.)
S12859-324				19.0 × 18.0				
S12858-422				19.0 × 10.2	Phosphor sheet	Small	High	X-ray non-destructive inspection (at low X-ray energy)
S12859-422				19.0 × 18.0				

*1: Relative characteristics when three types of scintillators are compared

*2: This photodiode array as it is does not function as an X-ray detector. An appropriate scintillator or phosphor sheet should be added at user's side.

Note: The S12858/S12859 series are also compatible with other scintillators than those listed in the above table (custom made devices). Please consult our sales office.

Precautions

CsI(Tl) scintillator of the S12858/S12859-122 has deliquescence. Avoid storing or using the S12858/S12859-122 at high humidity.

Feature 01 Back-illuminated type

The S12858/S12859 series photodiode arrays have a back-illuminated type structure. This structure uses no fragile easily-broken bonding wires since the photodiode array output terminals are directly connected by bump bonding to the electrodes on the board. This structure is robust since the board wiring is laid out within the board. The photodiode surface for coupling the scintillator has no bonding wires or photosensitive areas, so there is less risk of damaging the photodiode array. The S12858/S12859 series is also resistant to effects from temperature cycle and so ensures high reliability.

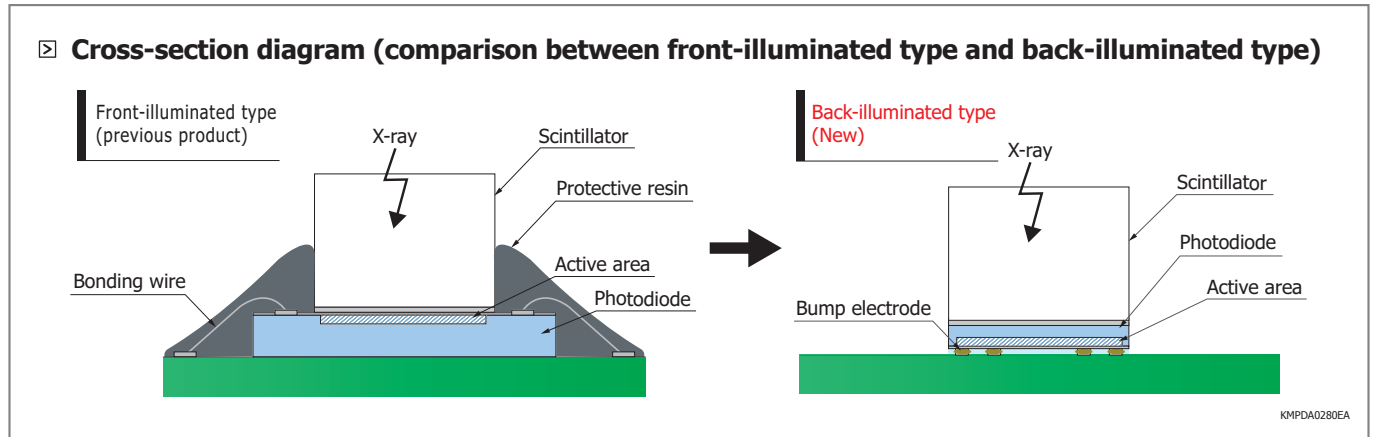

Feature 02 Multiple applications

The S12858/S12859 series supports dual energy imaging. To simultaneously detect high energy X-rays and low energy X-rays, the S12858/S12859 series is designed so that two photodiode arrays, each with a different scintillator, are combined in an upper and lower two-layer format. Arranging two or more S12858/S12859 series photodiode arrays in a row in close proximity also forms a line sensor that allows measurement of long objects.

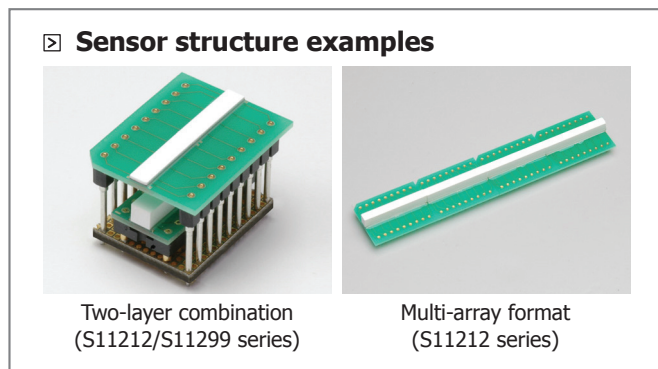

Absolute maximum ratings

Parameter	Symbol	-021	-122, -324, -422	Unit
Reverse voltage	VR max	10		V
Operating temperature*3	Topr	-20 to +60	-10 to +60	°C
Storage temperature*3	Tstg	-20 to +80	-20 to +70	°C

*3: No dew condensation

When there is a temperature difference between a product and the surrounding area in high humidity environment, dew condensation may occur on the product surface. Dew condensation on the product may cause deterioration in characteristics and reliability.

Note: Exceeding the absolute maximum ratings even momentarily may cause a drop in product quality. Always be sure to use the product within the absolute maximum ratings.

Electrical and optical characteristics (Ta=25 °C, per element, S12858-021 characteristics except X-ray sensitivity)

Parameter	Symbol	Condition	Min.	Typ.	Max.	Unit	
Spectral response range	λ		-	340 to 1100	-	nm	
Peak sensitivity wavelength	λ_p		-	920	-	nm	
Photosensitivity	S	$\lambda=540$ nm	380	420	460	mA/W	
		$\lambda=\lambda_p$	550	610	670		
Short circuit current	Isc	*4	2.1	3.2	-	μ A	
X-ray sensitivity	IscX	*5	-122	-	5.0	-	nA
			-324	-	2.5	-	
			-422	-	2.2	-	
Dark current	ID	VR=10 mV	-	3	30	pA	
Rise time	tr	VR=0 V, RL=1 k Ω 10 to 90%, $\lambda=658$ nm	-	6.5	-	μ s	
Terminal capacitance	Ct	VR=0 V, f=10 kHz	20	30	40	pF	

*4: 100 lx, 2856 K

*5: These are reference (X-ray tube voltage 120 kV, tube current 1.0 mA, aluminum filter t=6 mm, 830 mm). X-ray sensitivity depends on the X-ray equipment operating and setup conditions.

Spectral response (characteristics without scintillator)

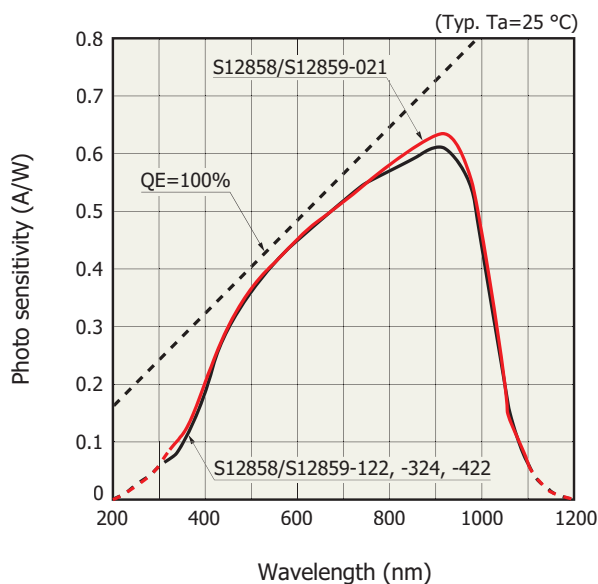

Spectral response characteristics of the S12858/S12859-122, -324, -422 include the transmittance and reflectance of the adhesive resin used to bond a scintillator.

KMPD0471EA

■ Emission spectrum of scintillator and spectral response

S12858/S12859-122

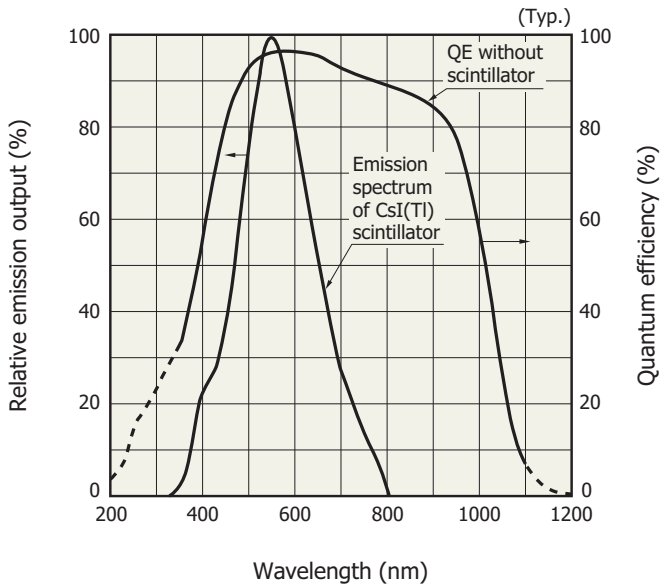

KSPD80282EE

S12858/S12859-324

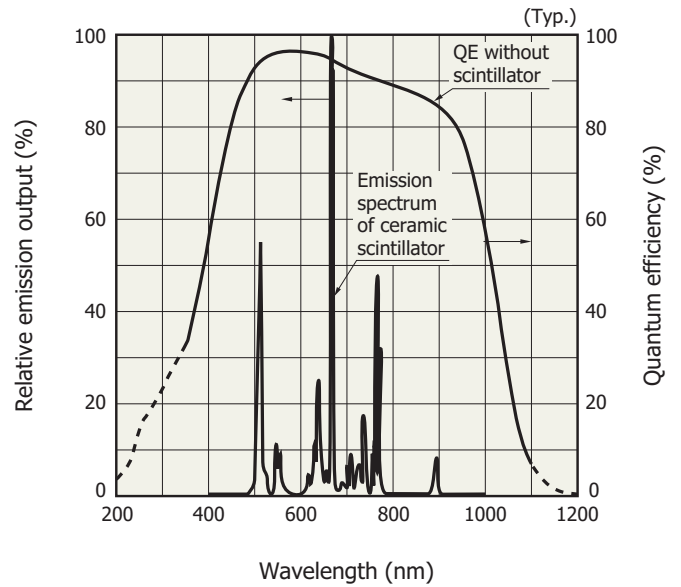

KSPD80281EE

■ Scintillator specifications

Parameter	Condition	CsI(Tl)	Ceramic	Unit
Peak emission wavelength		560	512	nm
X-ray absorption coefficient	100 keV	10	7	cm ⁻¹
Refractive index	at peak emission wavelength	1.7	2.2	-
Decay constant		1	3	μs
Afterglow	100 ms after X-ray turn off	0.3	0.01	%
Density		4.51	7.34	g/cm ³
Color		Transparent	Light yellow-green	-
Sensitivity non-uniformity		±10	±5	%

Dimensional outlines (unit: mm)

S12858-021

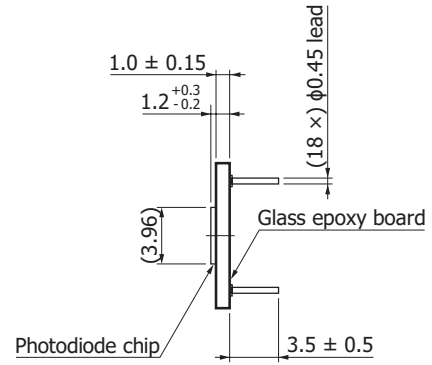
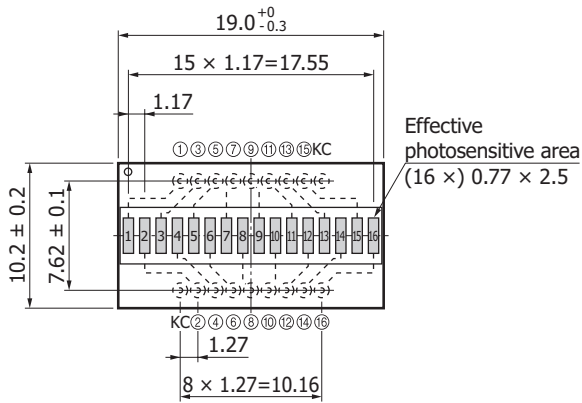

Tolerance unless otherwise noted: ± 0.1
 Chip center position accuracy
 (with respect to package center)
 X: ± 0.1
 Y: ± 0.2

KMPDA0343EA

S12859-021

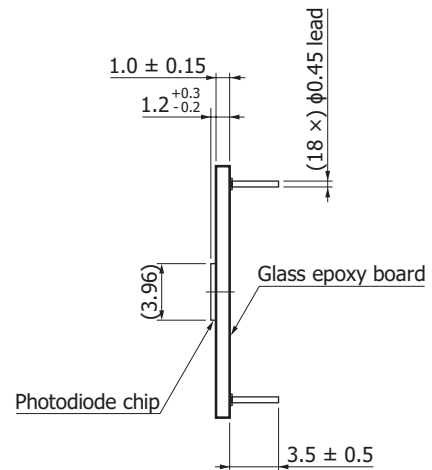
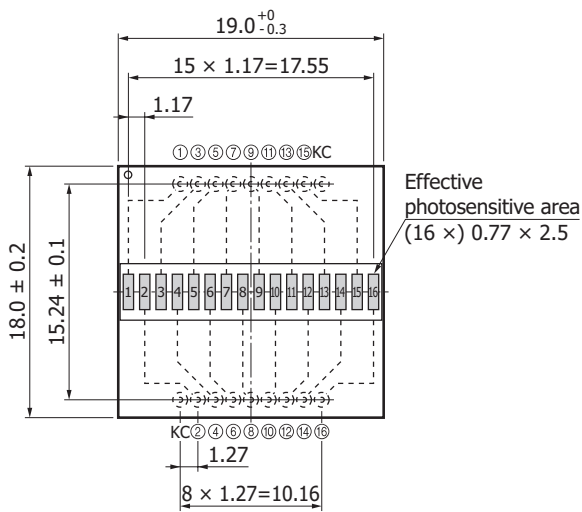

Tolerance unless otherwise noted: ± 0.1
 Chip center position accuracy
 (with respect to package center)
 X: ± 0.1
 Y: ± 0.2

KMPDA0344EA

S12858-122

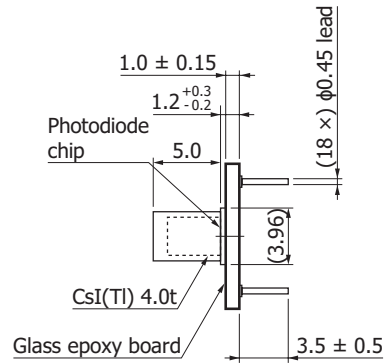
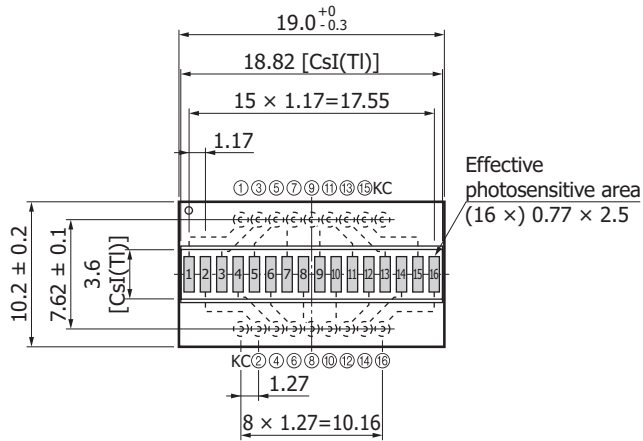

Tolerance unless otherwise noted: ± 0.1
 Chip center position accuracy
 (with respect to package center)
 X: ± 0.1
 Y: ± 0.2

KMPDA0345EA

S12859-122

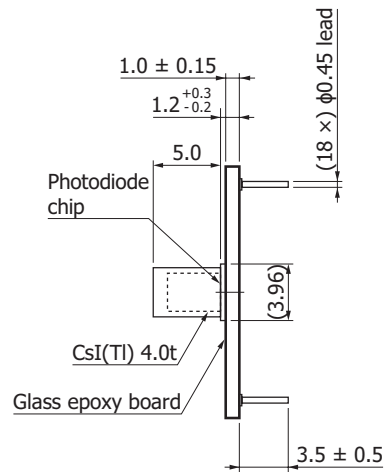
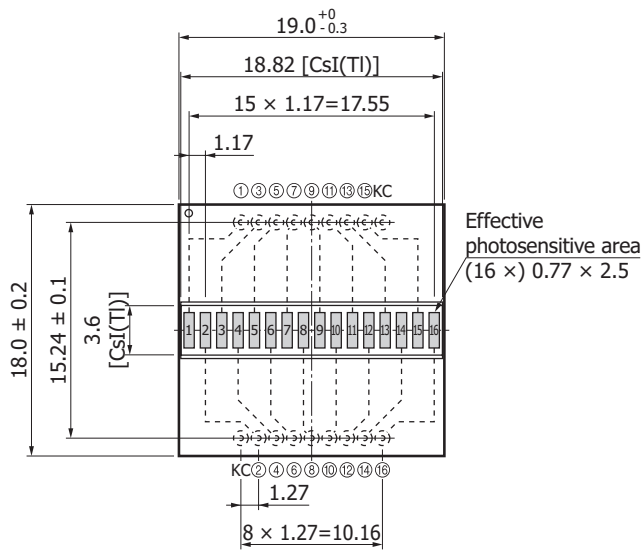

Tolerance unless otherwise noted: ± 0.1
 Chip center position accuracy
 (with respect to package center)
 X: ± 0.1
 Y: ± 0.2

KMPDA0346EA

S12858-324

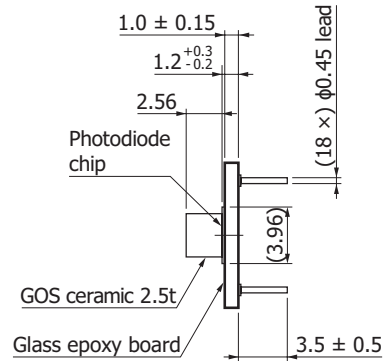
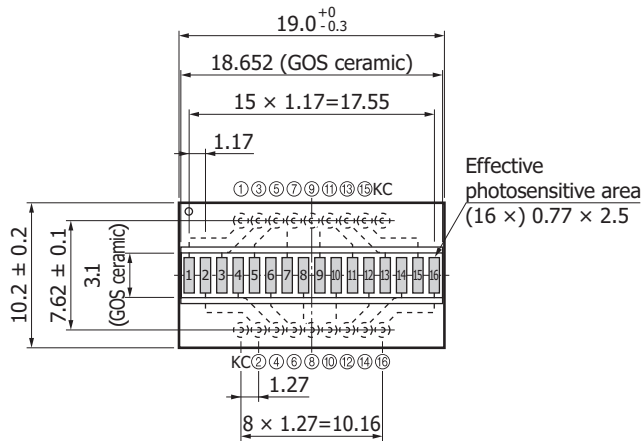

Tolerance unless otherwise noted: ± 0.1
 Chip center position accuracy
 (with respect to package center)
 X: ± 0.1
 Y: ± 0.2

KMPDA0347EA

S12859-324

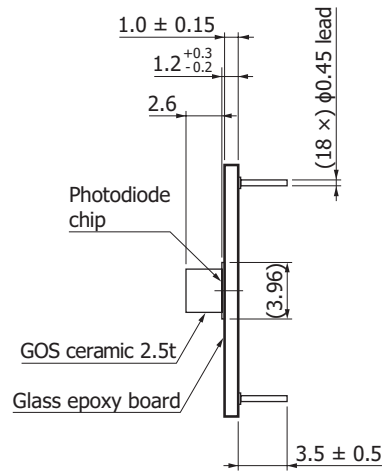
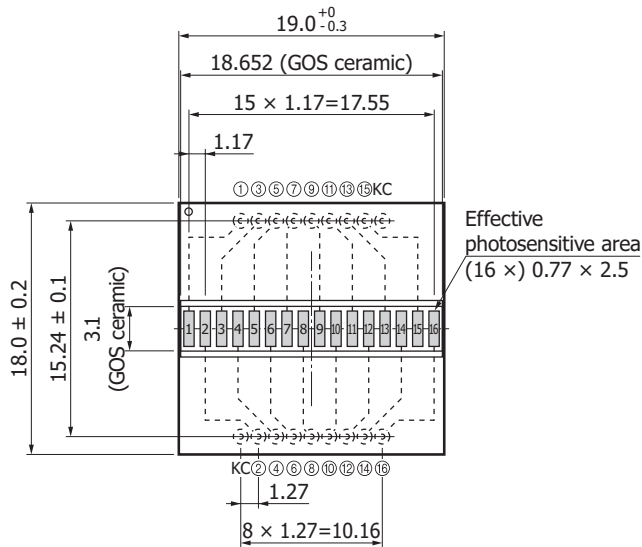

Tolerance unless otherwise noted: ± 0.1
 Chip center position accuracy
 (with respect to package center)
 X: ± 0.1
 Y: ± 0.2

KMPDA0348EA

S12858-422

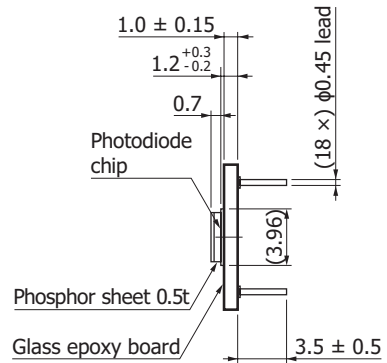
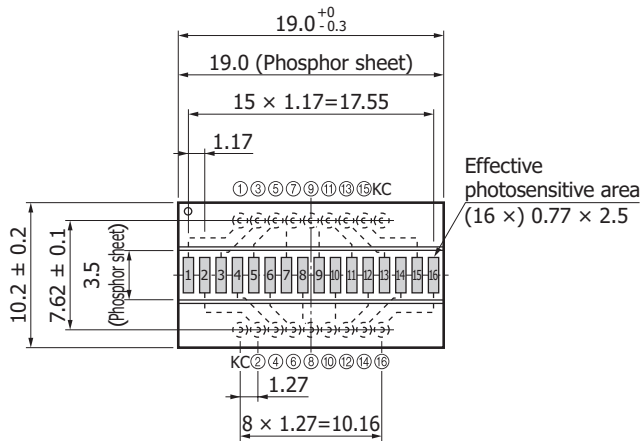

Tolerance unless otherwise noted: ± 0.1
 Chip center position accuracy
 (with respect to package center)
 X: ± 0.1
 Y: ± 0.2

KMPDA0349EA

S12859-422

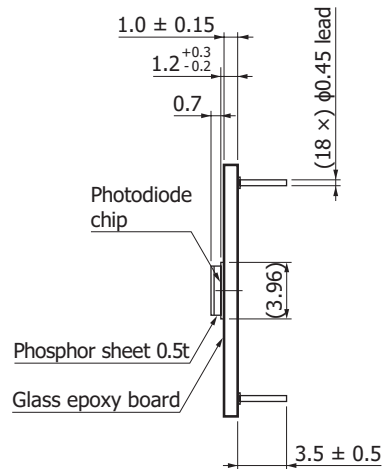
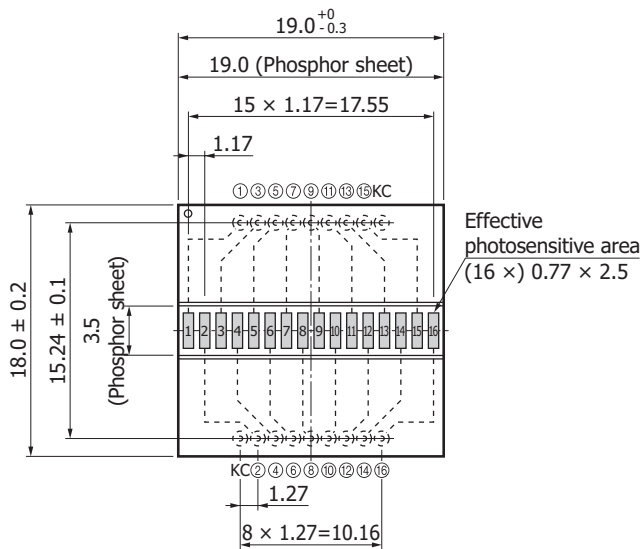

Tolerance unless otherwise noted: ± 0.1
 Chip center position accuracy
 (with respect to package center)
 X: ± 0.1
 Y: ± 0.2

KMPDA0350EA

☒ Combination examples (for dual energy imaging)

Dual energy imaging is a technique that acquires and superimposes two types of data in a single scan by using X-rays at two different energy levels (high energy and low energy). Two photodiode arrays with scintillators are used: one at the upper stage and the other at the lower stage. The upper stage is used for low energy detection, and the lower stage for high energy detection. Arranging two or more of these devices in a row also forms a line sensor for dual energy imaging.

① This combination uses the S12858 series in both upper and lower stages.

- [Upper stage] S12858-422 + [Lower stage] S12858-122
- [Upper stage] S12858-422 + [Lower stage] S12858-324

② This combination uses the S12859 series in the upper stage and the S12858 series in the lower stage

- [Upper stage] S12859-422 + [Lower stage] S12858-122
- [Upper stage] S12859-422 + [Lower stage] S12858-324

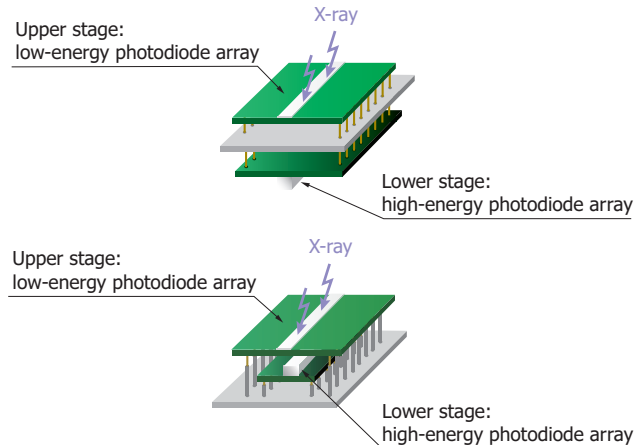

■ Related information

www.hamamatsu.com/sp/ssd/doc_en.html

■ Precautions

- Disclaimer
- Metal, ceramic, plastic package products

Information described in this material is current as of September 2017.

Product specifications are subject to change without prior notice due to improvements or other reasons. This document has been carefully prepared and the information contained is believed to be accurate. In rare cases, however, there may be inaccuracies such as text errors. Before using these products, always contact us for the delivery specification sheet to check the latest specifications.

The product warranty is valid for one year after delivery and is limited to product repair or replacement for defects discovered and reported to us within that one year period. However, even if within the warranty period we accept absolutely no liability for any loss caused by natural disasters or improper product use. Copying or reprinting the contents described in this material in whole or in part is prohibited without our prior permission.

HAMAMATSU

www.hamamatsu.com

HAMAMATSU PHOTONICS K.K., Solid State Division

1126-1 Ichino-cho, Higashi-ku, Hamamatsu City, 435-8558 Japan, Telephone: (81) 53-434-3311, Fax: (81) 53-434-5184

U.S.A.: Hamamatsu Corporation: 360 Foothill Road, Bridgewater, N.J. 08807, U.S.A., Telephone: (1) 908-231-0960, Fax: (1) 908-231-1218, E-mail: usa@hamamatsu.com

Germany: Hamamatsu Photonics Deutschland GmbH: Arzbergerstr. 10, D-82211 Herrsching am Ammersee, Germany, Telephone: (49) 8152-375-0, Fax: (49) 8152-265-8, E-mail: info@hamamatsu.de

France: Hamamatsu Photonics France S.A.R.L.: 19, Rue du Saule Trapu, Parc du Moulin de Massy, 91882 Massy Cedex, France, Telephone: 33-(1) 69 53 71 00, Fax: 33-(1) 69 53 71 10, E-mail: infos@hamamatsu.fr

United Kingdom: Hamamatsu Photonics UK Limited: 2 Howard Court, 10 Tewin Road, Welwyn Garden City, Hertfordshire AL7 1BW, United Kingdom, Telephone: (44) 1707-294888, Fax: (44) 1707-325777, E-mail: info@hamamatsu.co.uk

North Europe: Hamamatsu Photonics Norden AB: Torshamnsgatan 35 16440 Kista, Sweden, Telephone: (46)8-509 031 00, Fax: (46)8-509 031 01, E-mail: info@hamamatsu.se

Italy: Hamamatsu Photonics Italia S.r.l.: Strada della Moia, 1 int. 6, 20020 Arese (Milano), Italy, Telephone: (39)02-93 58 17 33, Fax: (39)02-93 58 17 41, E-mail: info@hamamatsu.it

China: Hamamatsu Photonics (China) Co., Ltd.: B1201, Jiaming Center, No.27 Dongsanhuan Beilu, Chaoyang District, Beijing 100020, China, Telephone: (86) 10-6586-6006, Fax: (86) 10-6586-2866, E-mail: hpc@hamamatsu.com.cn

Taiwan: Hamamatsu Photonics Taiwan Co., Ltd.: 8F-3, No.158, Section2, Gongdao 5th Road, East District, Hsinchu, 300, Taiwan R.O.C. Telephone: (886)03-659-0080, Fax: (886)03-659-0081, E-mail: info@tw.hpk.co.jp