

FEATURES

- Dropout Voltage 1.2V at 800mA Output Current.
- Fast Transient Response.
- Line Regulation, typical at 0.015%.
- Load Regulation, typical at 0.1%.
- Current Limiting and Thermal Protection.
- Adjustable Output Voltage or Fixed at 1.8V, 2.5V and 3.3V.
- Standard 3-Pin Power Packages.

APPLICATIONS

- Active SCSI Terminators.
- Post Regulators for Switching Supplies.
- Battery Chargers.
- PC Add-On Card.

DESCRIPTION

The AIC1117 is a low dropout, three terminals regulator designed to provide output current up to 800mA. The device is available in an adjustable version and fixed output voltage of 1.8V, 2.5V and 3.3V. Dropout voltage of maximum of 1.4V is guaranteed at 800mA output current. The quality of low dropout voltage and fast transient response make this device ideal for low voltage microprocessor applications.

The AIC1117 requires output capacitance of a minimum of 10 μ F for stability. Built-in output current limiting and thermal limiting provide maximal protection to the AIC1117 against fault conditions.

TYPICAL APPLICATION CIRCUIT

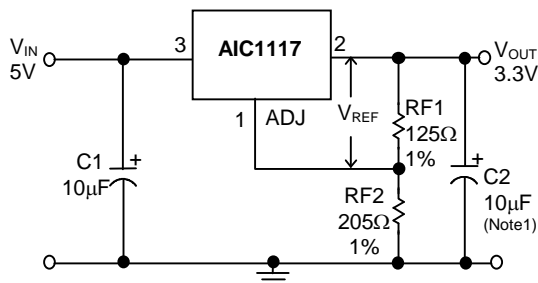

Adjustable Voltage Regulator

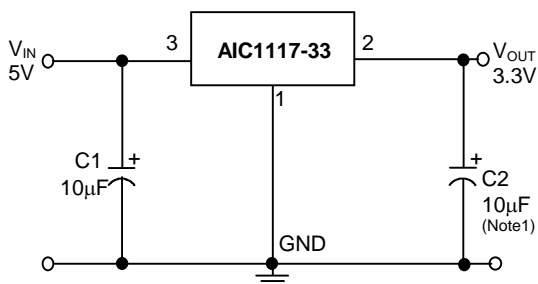

Fixed Voltage Regulator

$$V_{REF} = V_{OUT} - V_{ADJ} = 1.25V \text{ (typ.)}$$

$$V_{OUT} = V_{REF} \times (1 + RF2/RF1) + I_{ADJ} \times RF2$$

$$I_{ADJ} = 55\mu A \text{ (typ.)}$$

- (1) C1 needed if device is far away from filter capacitors.
- (2) C2 required for stability.

ORDERING INFORMATION

AIC1117-XXXXXX

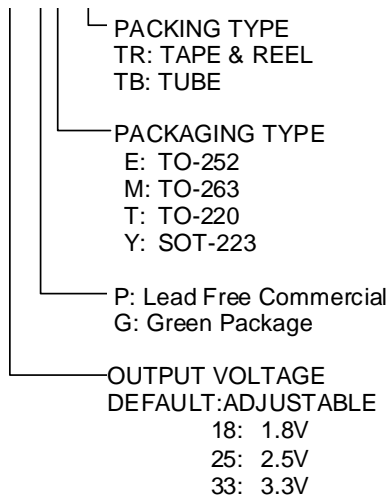

Example: AIC1117-25GETR
 → 2.5V version in TO-252 Green Package & Taping & Reel Packing Type
 AIC1117-25PYTR
 → 2.5V version in SOT-223 Lead Free Package & Taping & Reel

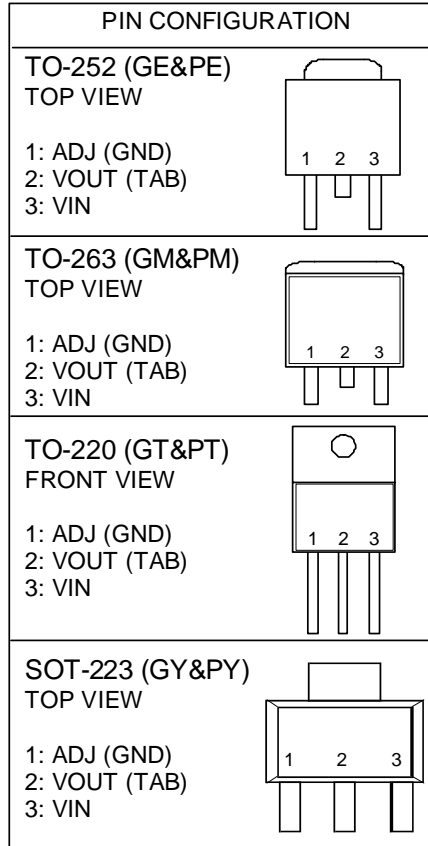

● SOT-223 Marking

Part No.	GY	PY
AIC1117	AK17G	AK17P
AIC1117-18	AK18G	AK18P
AIC1117-25	AK25G	AK25P
AIC1117-33	AK33G	AK33P

■ ABSOLUTE MAXIMUM RATINGS

VIN pin to ADJ/ GND pin	7V
Operating Temperature Range	-40°C to 85°C
Storage Temperature Range	-65°C to 150°C
Maximum Junction Temperature	125°C
Lead Temperature (Soldering, 10 sec)	260°C
Thermal Resistance (Junction to Case)	TO-220.....	3°C /W
	TO-252.....	12.5°C /W
	SOT-223.....	15°C /W
	TO-263.....	3°C /W
Thermal Resistance Junction to Ambient	TO-252.....	100°C/W
(Assume no ambient airflow, no heatsink)	TO-263.....	60°C /W
	SOT-223.....	155°C /W
	TO-220.....	50°C /W

Absolute Maximum Ratings are those values beyond which the life of a device may be impaired.

■ TEST CIRCUIT

Refer to TYPICAL APPLICATION CIRCUIT.

■ ELECTRICAL CHARACTERISTICS
(V_{IN}=5V, T_A=25°C, I_O=10mA, unless otherwise specified) (Note2)

PARAMETER	TEST CONDITIONS	MIN.	TYP.	MAX.	UNIT
Reference Voltage	AIC1117 (ADJ), T _J =25°C	1.238	1.25	1.262	V
	0°C≤T _J ≤125°C	1.225	1.25	1.275	
Output Voltage	AIC1117-18, V _{IN} =3.3V	1.78	1.8	1.82	V
	AIC1117-25, V _{IN} =5V	2.47	2.5	2.53	
	AIC1117-33, V _{IN} =5V	3.26	3.30	3.33	
Line Regulation	2.65≤V _{IN} ≤7V, V _{OUT} =1.25V T _J =25°C		0.015	0.2	%
	0°C≤T _J ≤125°C		0.035	0.2	
Load Regulation	T _J =25°C 10mA ≤I _O ≤800mA		0.1	0.3	%
	0°C≤T _J ≤125°C		0.2	0.4	
Dropout Voltage	ΔV _{OUT} , ΔV _{REF} =1% 10mA≤I _O ≤800mA		1.2	1.4	V
Current Limit		0.85			A
Adjusted Pin Current (I _{ADJ})	2.65≤V _{IN} ≤7V 10mA≤I _O ≤800mA		55	120	μA
Adjusted Pin Current Change (ΔI _{ADJ})	2.65≤V _{IN} ≤7V 10mA≤I _O ≤800mA		0.2	5	μA
Temperature Stability	I _O =0.5A		0.5		%
Minimum Load Current			5	10	mA
GND Current	2.65≤V _{IN} ≤7V		10	14	mA
RMS Output Noise (% of V _{OUT})	10Hz ≤ f ≤ 10KHz		0.003		%
Ripple Rejection Ratio	120Hz input ripple C _{OUT} =25μF	60	72		dB

Note 1: To avoid output oscillation, aluminum electrolytic output capacitor is recommended and ceramic capacitor is not suggested.

Note 2: Specifications are production tested at T_A=25°C. Specifications over the -40°C to 85°C operating temperature range are assured by design, characterization and correlation with Statistical Quality Controls (SQC).

■ TYPICAL PERFORMANCE CHARACTERISTICS

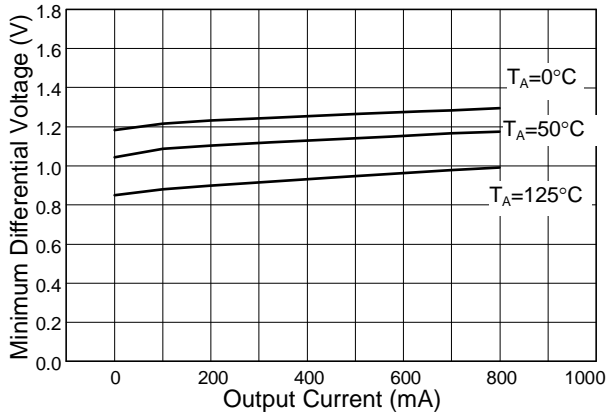

Fig. 1 AIC1117 (ADJ) Dropout Voltage

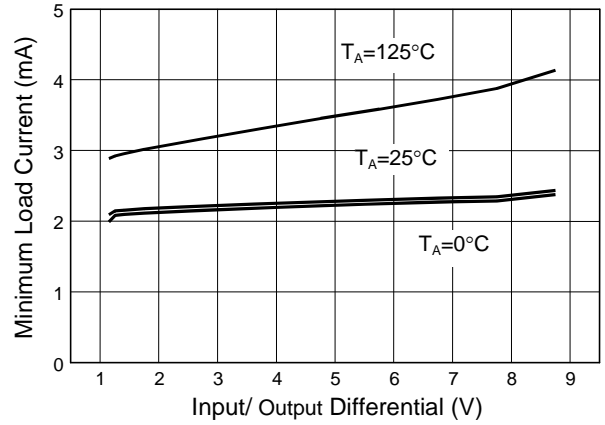

Fig. 2 Minimum Load Current (Adjustable Version)

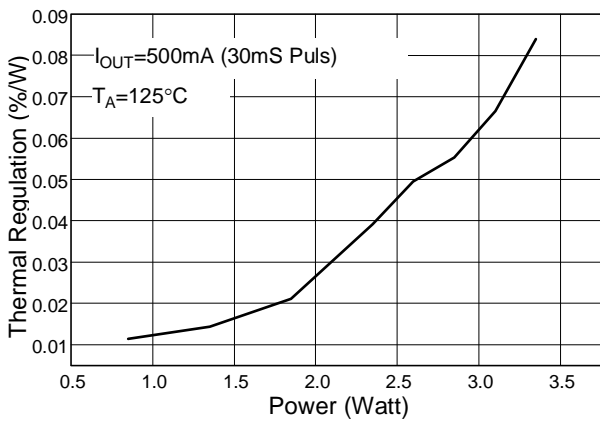

Fig. 3 AIC1117 (ADJ) Power vs. Thermal Regulation

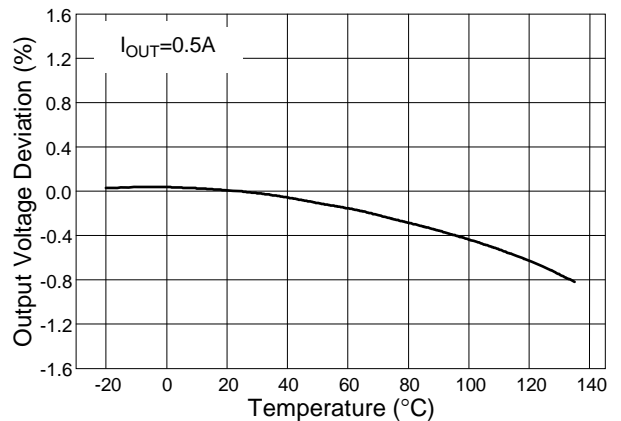

Fig. 4 AIC1117 (ADJ) Temperature Stability

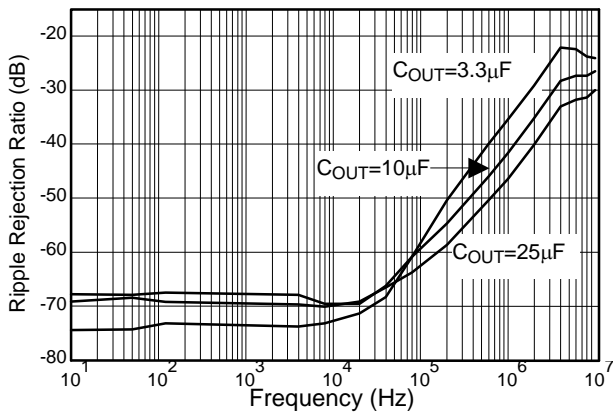

Fig. 5 AIC1117 (ADJ) Ripple Rejection Ratio (dB)

■ TYPICAL PERFORMANCE CHARACTERISTICS (Continued)

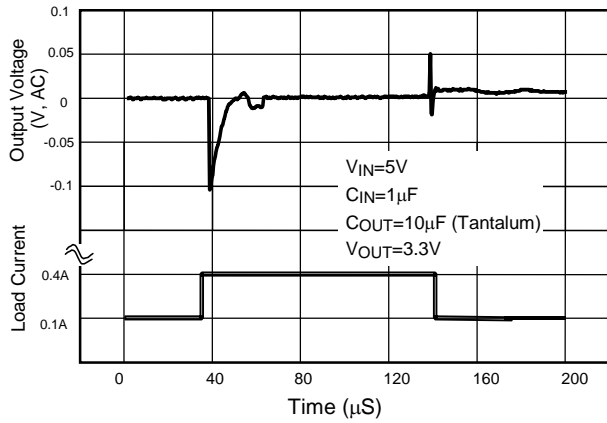

Fig. 6 Load Transient Response

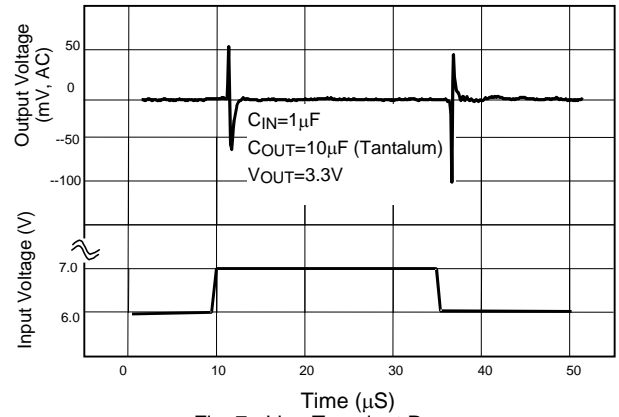

Fig. 7 Line Transient Response

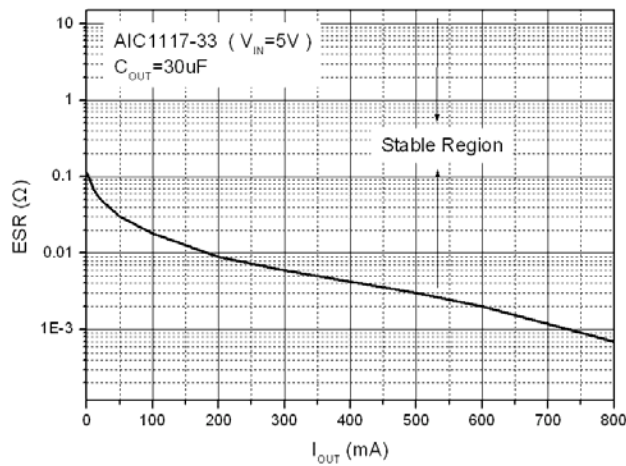

Fig. 8 Region of Stable C_{OUT} ESR vs. Load Current

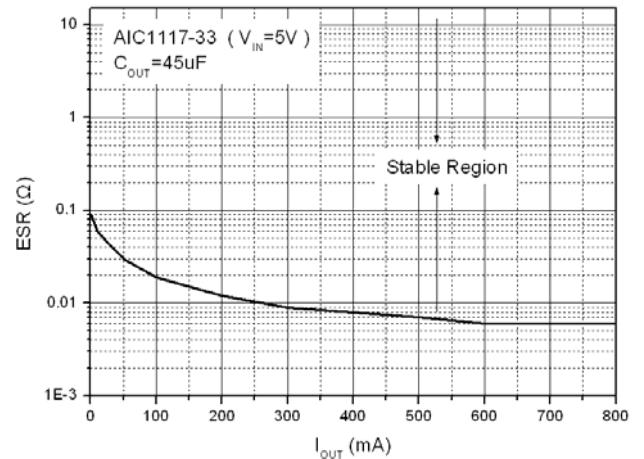
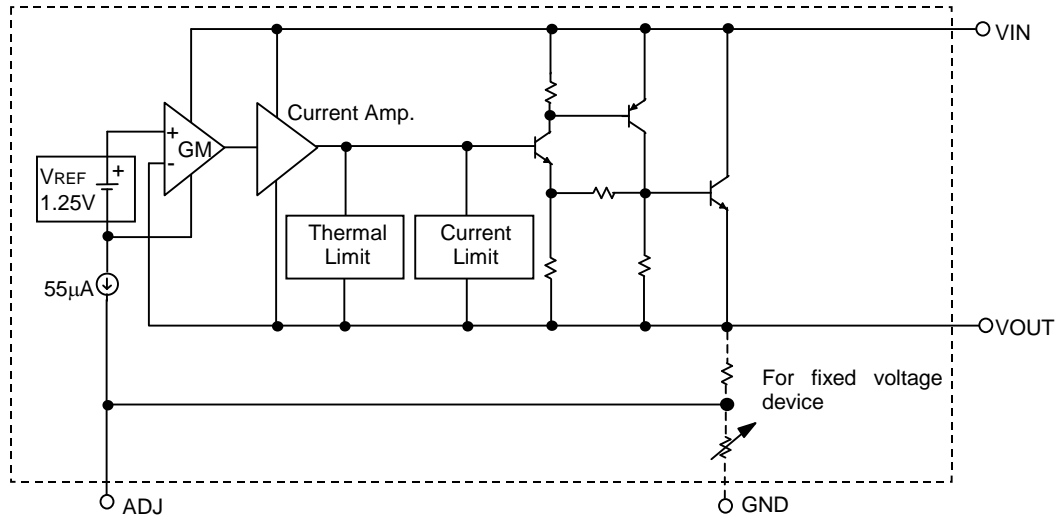

Fig. 9 Region of Stable C_{OUT} ESR vs. Load Current

■ BLOCK DIAGRAM



■ PIN DESCRIPTIONS

- ADJ PIN - Providing $V_{REF}=1.25V$ (typ.) for adjustable V_{OUT} . $V_{REF}=V_{OUT}-V_{ADJ}$ and $I_{ADJ}=55\mu A$ (typ.) (GND PIN - Power ground.)
- VOUT PIN - Adjustable output voltage.
- VIN PIN - Power Input.

APPLICATION INFORMATION

INPUT-OUTPUT CAPACITORS

Linear regulators require input and output capacitors to maintain stability. Input capacitor at 10 μ F with a 10 μ F aluminum electrolytic output capacitor is recommended. To avoid oscillation, it is recommended to follow Fig. 8, 9 to choose proper capacitor specifications.

POWER DISSIPATION

The AIC1117 obtains thermal-limiting circuitry, which is designed to protect the device against overload condition. For continuous load condition, maximum rating of junction temperature must not be exceeded. It is important to pay more attention in thermal resistance. It includes junction to case, junction to ambient. The maximum power dissipation of AIC1117 depends on the thermal resistance of its case and circuit board, the temperature difference between the die junction and ambient air, and the rate of airflow. The rate of

temperature rise is greatly affected by the mounting pad configuration on the PCB, the board material, and the ambient temperature. When the IC mounting with good thermal conductivity is used, the junction temperature will be low even when large power dissipation applies.

The power dissipation across the device is

$$P = I_{OUT} (V_{IN} - V_{OUT}).$$

The maximum power dissipation is:

$$P_{MAX} = \frac{(T_{J-max} - T_A)}{R\theta_{JA}}$$

Where T_{J-max} is the maximum allowable junction temperature (125 $^{\circ}$ C), and T_A is the ambient temperature suitable in application.

As a general rule, the lower temperature is, the better reliability of the device is. So the PCB mounting pad should provide maximum thermal conductivity to maintain low device temperature.

APPLICATION EXAMPLES

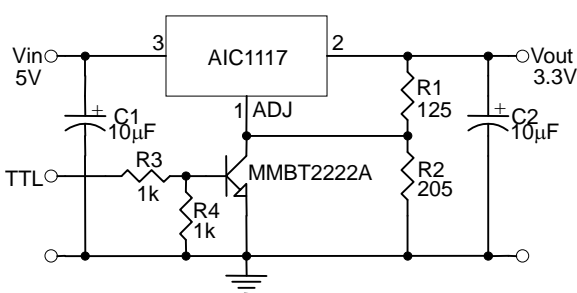
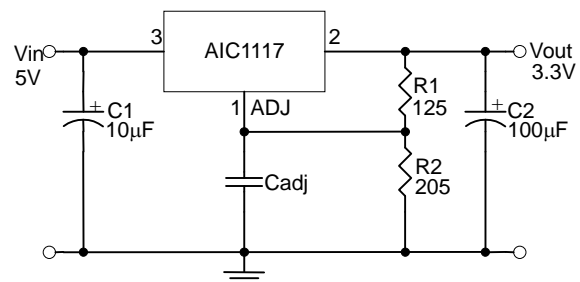

Fig. 10 $V_{OUT}=3.3V$ with Shutdown



* Cadj can improve ripple rejection

Fig. 11 Improving Ripple Rejection

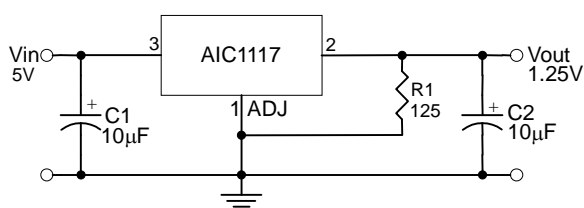

Fig. 12 $V_{OUT}=1.25V$ Application Circuit

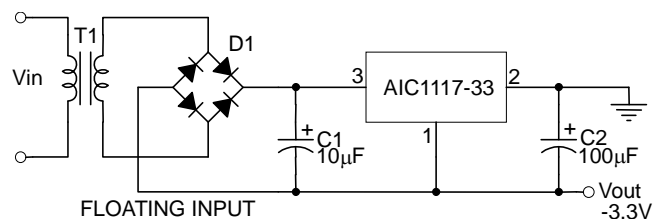
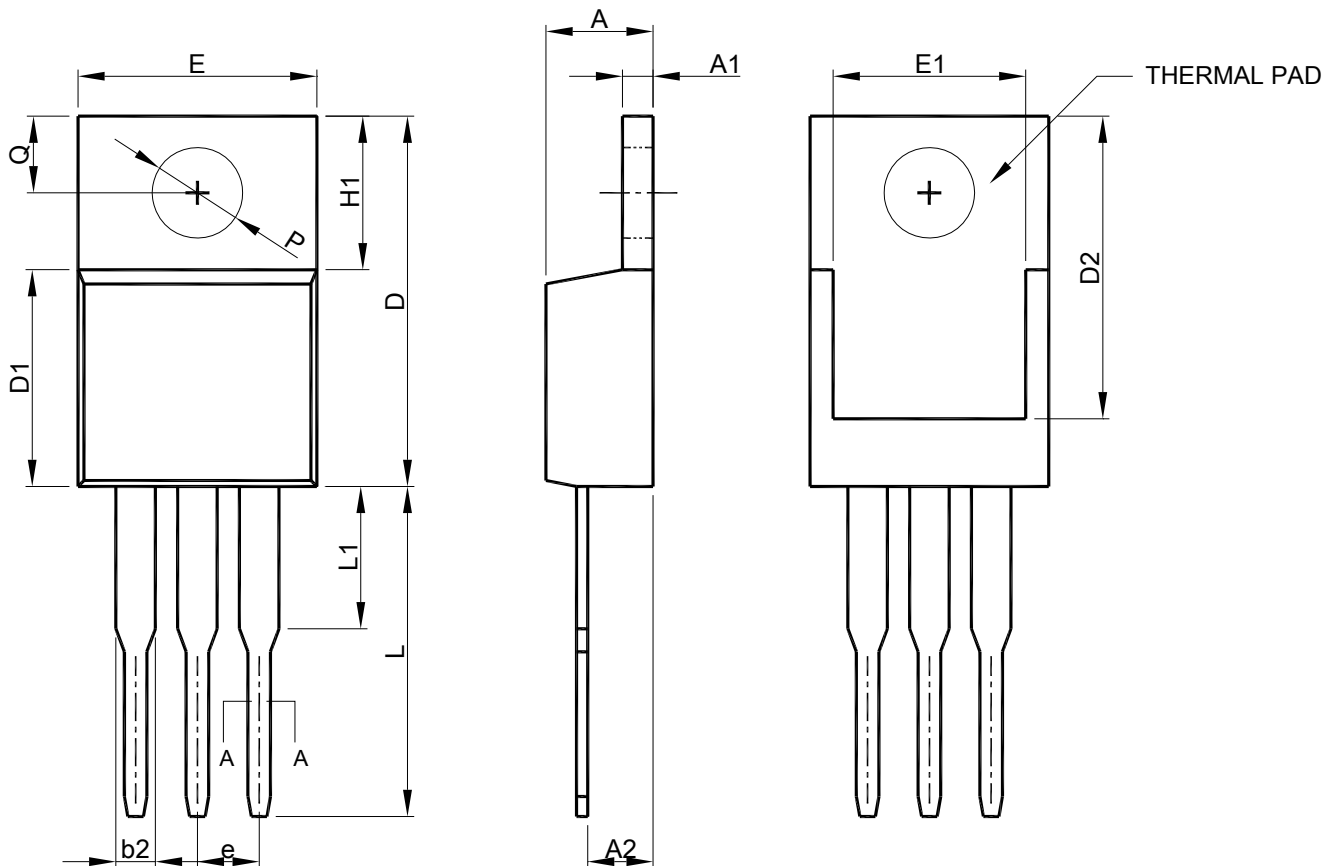

Fig. 13 Low Dropout Negative Supply

■ PHYSICAL DIMENSIONS (unit: mm)

- TO-220



SYMBOL	TO-220	
	MILLIMETERS	
	MIN.	MAX.
A	3.56	4.82
A1	0.51	1.39
A2	2.04	2.92
b	0.38	1.01
b2	1.15	1.77
c	0.35	0.61
D	14.23	16.51
D1	8.38	9.02
D2	11.75	12.88
E	9.66	10.66
E1	6.86	8.90
e	2.54 BSC	
H1	5.85	6.85
L	12.70	14.73
L1	--	6.35
P	3.54	4.08
Q	2.54	3.42

Note: 1. Refer to JEDEC TO-220AB.

2. Dimension "E" does not include mold flash, protrusions or gate burrs. Mold flash, protrusion or gate burrs shall not exceed 6 mil per side .

3. Dimension "D1" does not include inter-lead flash or protrusions.

4. Controlling dimension is millimeter, converted inch dimensions are not necessarily exact.

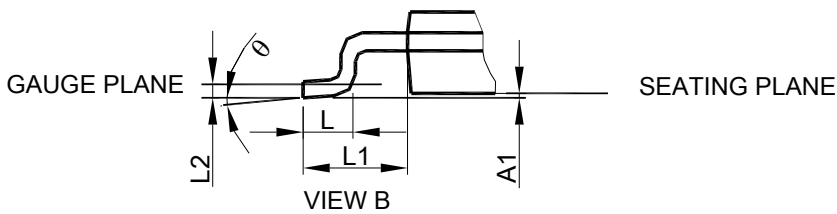
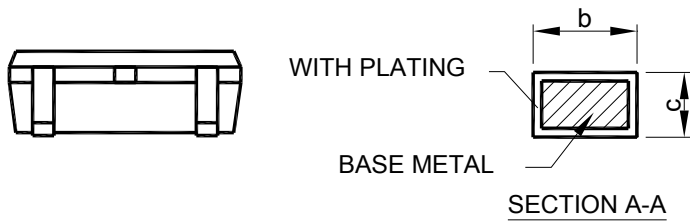
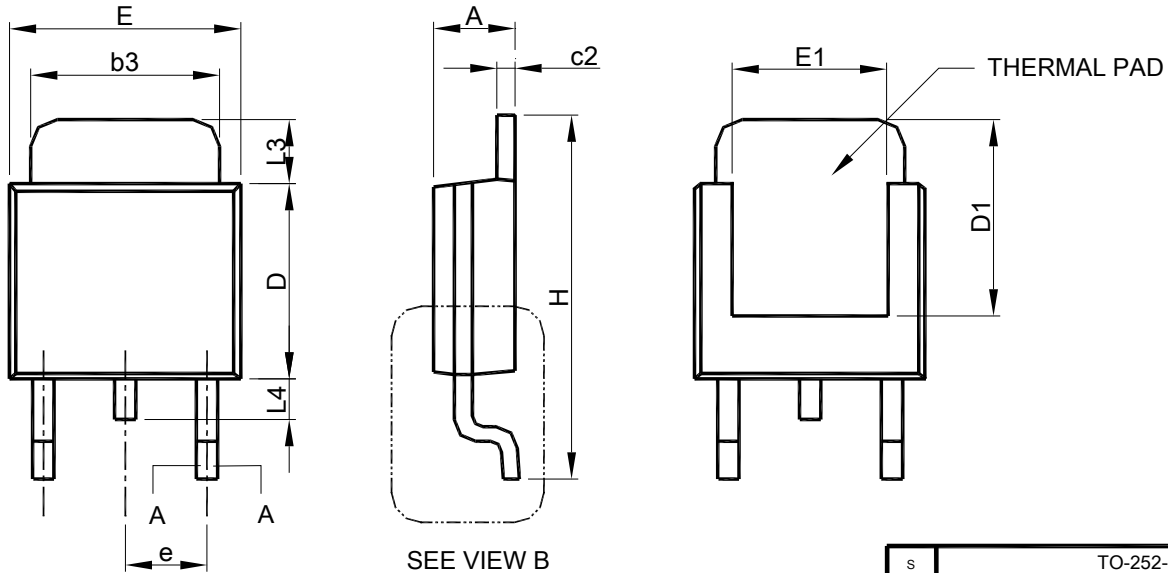
● TO-252

SYMBOL	TO-252-3L	
	MILLIMETERS	
	MIN.	MAX.
A	2.19	2.38
A1	0.00	0.13
b	0.64	0.89
b3	4.95	5.46
c	0.46	0.61
c2	0.46	0.89
D	5.33	6.22
D1	4.60	6.00
E	6.35	6.73
E1	3.90	5.46
e	2.28 BSC	
H	9.40	10.41
L	1.40	1.78
L1	2.67 REF	
L2	0.51 BSC	
L3	0.89	2.03
L4	--	1.02
θ	0°	8°

- Note: 1. Refer to JEDEC TO-252AA and AB.
 2. Dimension "E" does not include mold flash, protrusions or gate burrs. Mold flash, protrusion or gate burrs shall not exceed 6 mil per side .
 3. Dimension "D" does not include inter-lead flash or protrusions.
 4. Controlling dimension is millimeter, converted inch dimensions are not necessarily exact.

● SOT-223

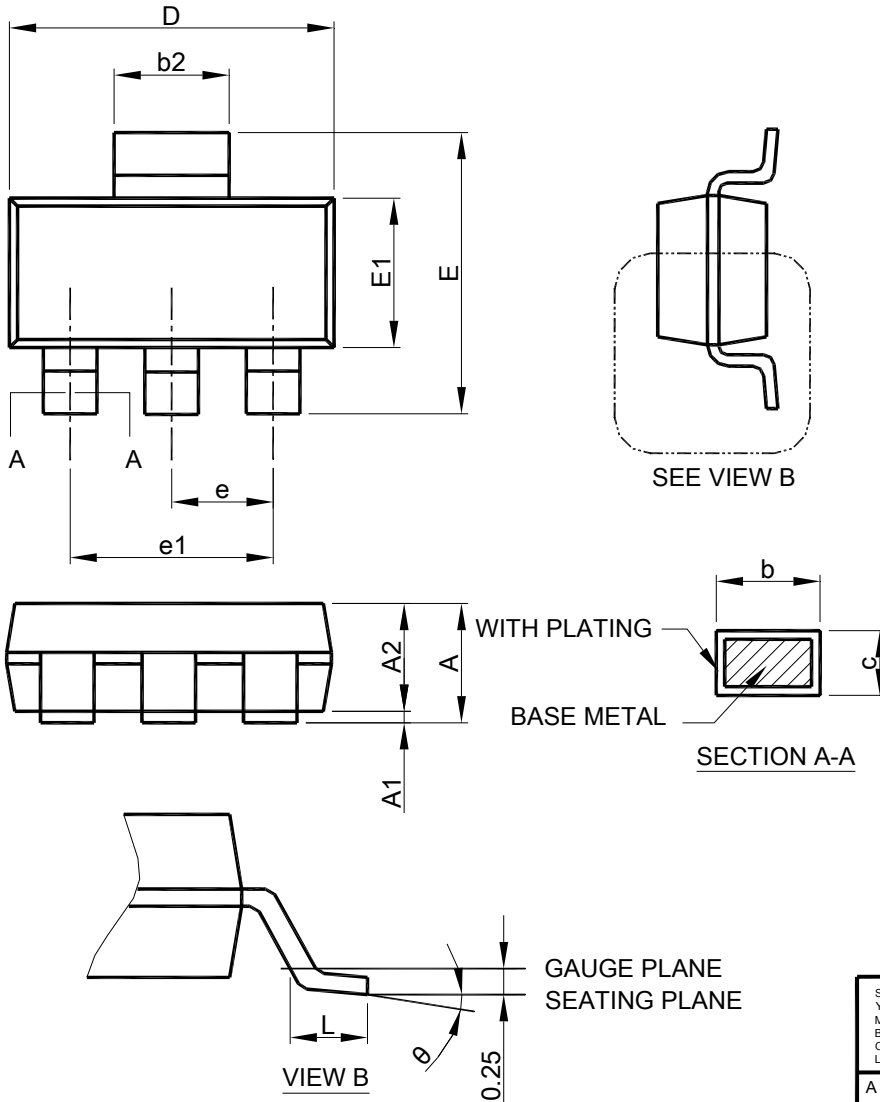

- Note: 1. Refer to JEDEC TO-261AA.
 2. Dimension "D" does not include mold flash, protrusions or gate burrs. Mold flash, protrusion or gate burrs shall not exceed 6 mil per side .
 3. Dimension "E1" does not include inter-lead flash or protrusions.
 4. Controlling dimension is millimeter, converted inch dimensions are not necessarily exact.

SYMBOL	SOT-223	
	MILLIMETERS	
	MIN.	MAX.
A		1.80
A1	0.02	0.10
A2	1.55	1.65
b	0.66	0.84
b2	2.90	3.10
c	0.23	0.33
D	6.30	6.70
E	6.70	7.30
E1	3.30	3.70
e	2.30 BSC	
e1	4.60 BSC	
L	0.90	
θ	0°	8°

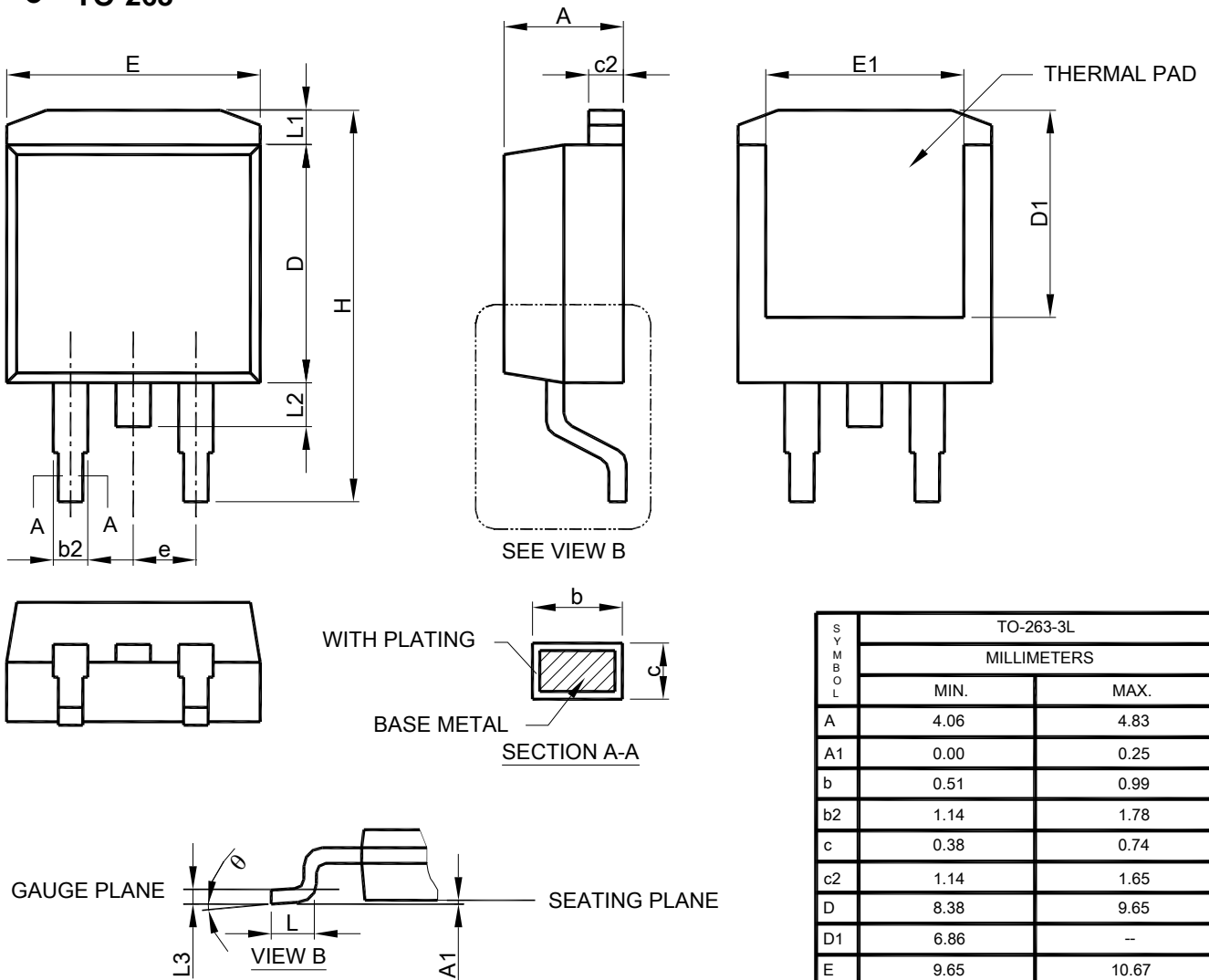
● TO-263

SYMBOL	TO-263-3L	
	MILLIMETERS	
	MIN.	MAX.
A	4.06	4.83
A1	0.00	0.25
b	0.51	0.99
b2	1.14	1.78
c	0.38	0.74
c2	1.14	1.65
D	8.38	9.65
D1	6.86	--
E	9.65	10.67
E1	6.23	--
e	2.54 BSC	
H	14.61	15.88
L	1.78	2.79
L1	--	1.68
L2	--	1.78
L3	0.25 BSC	
θ	0°	8°

- Note: 1. Refer to JEDEC TO-263AB.
 2. Dimension "E" does not include mold flash, protrusions or gate burrs. Mold flash, protrusion or gate burrs shall not exceed 6 mil per side.
 3. Dimension "D" does not include inter-lead flash or protrusions.
 4. Controlling dimension is millimeter, converted inch dimensions are not necessarily exact.

Note:

Information provided by AIC is believed to be accurate and reliable. However, we cannot assume responsibility for use of any circuitry other than circuitry entirely embodied in an AIC product; nor for any infringement of patents or other rights of third parties that may result from its use. We reserve the right to change the circuitry and specifications without notice.

Life Support Policy: AIC does not authorize any AIC product for use in life support devices and/or systems. Life support devices or systems are devices or systems which, (i) are intended for surgical implant into the body or (ii) support or sustain life, and whose failure to perform, when properly used in accordance with instructions for use provided in the labeling, can be reasonably expected to result in a significant injury to the user.