



SGM8621/SGM8622/SGM8623/SGM8624 3MHz, Rail-to-Rail I/O CMOS Operational Amplifiers

GENERAL DESCRIPTION

The SGM8621/2/3/4 are a family of single, dual and quad operational amplifiers, which are optimized for low voltage, low noise and low power operation. These devices can operate from 2V to 5.5V single supply, while consuming low quiescent current. The supply current of SGM8623 is less than 1 μ A in power-down mode.

The SGM8621/2/3/4 feature a 3mV maximum input offset voltage. The minimum input common mode voltage is within 0.1V below the negative rail, and the output swing is rail-to-rail with heavy loads. They exhibit a high gain-bandwidth product of 3MHz and a slew rate of 1.7V/ μ s. These specifications make the operational amplifiers appropriate for various applications.

The SGM8621 is available in Green SC70-5, SOT-23-5 and SOIC-8 packages. The SGM8622 is available in Green SOIC-8 and MSOP-8 packages. The SGM8623 is available in Green SOT-23-6 and SOIC-8 packages. The SGM8624 is available in Green SOIC-14 and TSSOP-14 packages. They are specified over the extended industrial temperature range (-40°C to +125°C).

FEATURES

- **Input Offset Voltage: 3mV (MAX)**
- **High Gain-Bandwidth Product: 3MHz**
- **High Slew Rate: 1.7V/ μ s**
- **Settling Time to 0.1% with 2V Step: 0.5 μ s**
- **Overload Recovery Time: 2.3 μ s**
- **Low Noise: 17.5nV/ $\sqrt{\text{Hz}}$ at 1kHz**
- **Rail-to-Rail Input and Output**
- **Supply Voltage Range: 2V to 5.5V**
- **Input Voltage Range: -0.1V to 5.6V with $V_S = 5.5V$**
- **Low Supply Current:**
 - SGM8621/3: 270 μ A (TYP)
 - SGM8622/4: 210 μ A/Amplifier (TYP)
 - SGM8623 Less than 1 μ A when Disabled
- **-40°C to +125°C Operating Temperature Range**
- **Small Packaging:**
 - SGM8621 Available in Green SC70-5, SOT-23-5 and SOIC-8 Packages
 - SGM8622 Available in Green MSOP-8 and SOIC-8 Packages
 - SGM8623 Available in Green SOT-23-6 and SOIC-8 Packages
 - SGM8624 Available in Green TSSOP-14 and SOIC-14 Packages

APPLICATIONS

Sensors
Audio
Active Filters
A/D Converters
Communications
Test Equipment
Cellular and Cordless Phones
Laptops and PDAs
Photodiode Amplification
Battery-Powered Instrumentation

PACKAGE/ORDERING INFORMATION

MODEL	PACKAGE DESCRIPTION	SPECIFIED TEMPERATURE RANGE	ORDERING NUMBER	PACKAGE MARKING	PACKING OPTION
SGM8621	SC70-5	-40°C to +125°C	SGM8621XC5/TR	8621	Tape and Reel, 3000
	SOT-23-5	-40°C to +125°C	SGM8621XN5/TR	8621	Tape and Reel, 3000
	SOIC-8	-40°C to +125°C	SGM8621XS/TR	SGM8621XS XXXXX	Tape and Reel, 2500
SGM8622	MSOP-8	-40°C to +125°C	SGM8622XMS/TR	SGM8622 XMS XXXXX	Tape and Reel, 3000
	SOIC-8	-40°C to +125°C	SGM8622XS/TR	SGM8622XS XXXXX	Tape and Reel, 2500
SGM8623	SOT-23-6	-40°C to +125°C	SGM8623XN6/TR	8623	Tape and Reel, 3000
	SOIC-8	-40°C to +125°C	SGM8623XS/TR	SGM8623XS XXXXX	Tape and Reel, 2500
SGM8624	SOIC-14	-40°C to +125°C	SGM8624XS14/TR	SGM8624XS14 XXXXX	Tape and Reel, 2500
	TSSOP-14	-40°C to +125°C	SGM8624XTS14/TR	SGM8624 XTS14 XXXXX	Tape and Reel, 3000

MARKING INFORMATION

NOTE: XXXXX = Date Code and Vendor Code.

SOIC-8/MSOP-8/SOIC-14/TSSOP-14

XXXXX

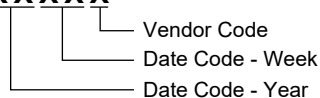

Green (RoHS & HSF): SG Micro Corp defines "Green" to mean Pb-Free (RoHS compatible) and free of halogen substances. If you have additional comments or questions, please contact your SGMICRO representative directly.

ABSOLUTE MAXIMUM RATINGS

Supply Voltage, +V _S to -V _S	6V
Input Common Mode Voltage Range (-V _S) - 0.3V to (+V _S) + 0.3V	
Package Thermal Resistance @ T _A = +25°C	
SC70-5, θ _{JA}	333°C/W
SOT-23-5, θ _{JA}	190°C/W
SOT-23-6, θ _{JA}	190°C/W
SOIC-8, θ _{JA}	125°C/W
MSOP-8, θ _{JA}	216°C/W
Junction Temperature	+150°C
Storage Temperature Range.....	-65°C to +150°C
Lead Temperature (Soldering, 10s)	+260°C
ESD Susceptibility	
HBM (SGM8621/2/4)	8000V
HBM (SGM8623)	4000V
MM.....	400V
CDM	1000V

RECOMMENDED OPERATING CONDITIONS

Operating Temperature Range	-40°C to +125°C
-----------------------------------	-----------------

OVERSTRESS CAUTION

Stresses beyond those listed in Absolute Maximum Ratings may cause permanent damage to the device. Exposure to absolute maximum rating conditions for extended periods may affect reliability. Functional operation of the device at any conditions beyond those indicated in the Recommended Operating Conditions section is not implied.

ESD SENSITIVITY CAUTION

This integrated circuit can be damaged if ESD protections are not considered carefully. SGMICRO recommends that all integrated circuits be handled with appropriate precautions. Failure to observe proper handling and installation procedures can cause damage. ESD damage can range from subtle performance degradation to complete device failure. Precision integrated circuits may be more susceptible to damage because even small parametric changes could cause the device not to meet the published specifications.

DISCLAIMER

SG Micro Corp reserves the right to make any change in circuit design, or specifications without prior notice.

PIN CONFIGURATIONS

SGM8621 (TOP VIEW)

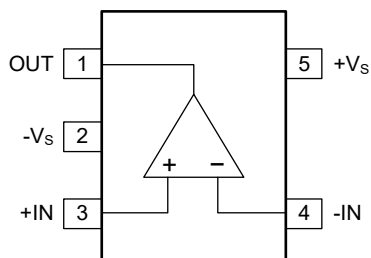

SC70-5/SOT-23-5

SGM8623 (TOP VIEW)

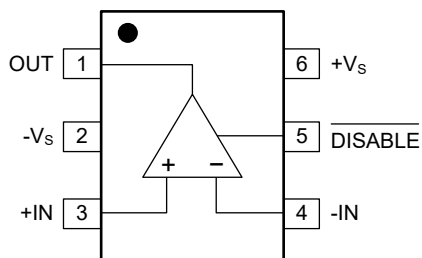

SOT-23-6

SGM8622 (TOP VIEW)

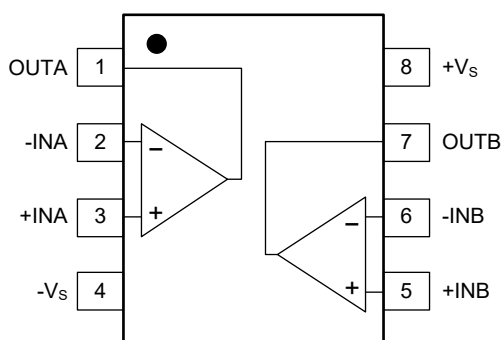

SOIC-8/MSOP-8

SGM8621/SGM8623 (TOP VIEW)

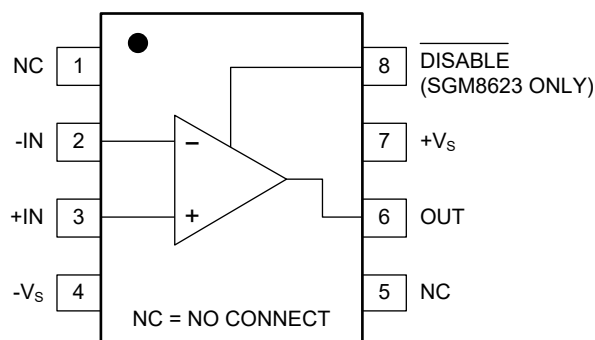

SOIC-8

SGM8624 (TOP VIEW)

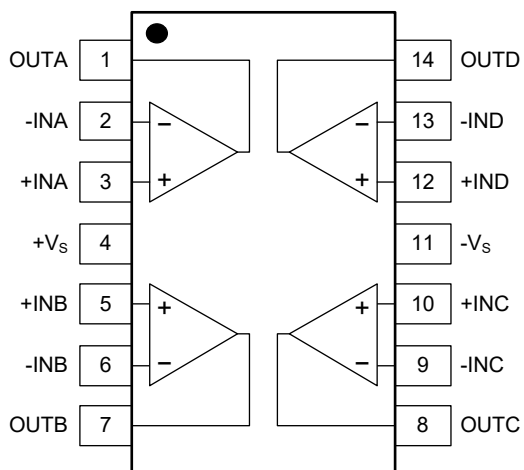

SOIC-14/TSSOP-14

ELECTRICAL CHARACTERISTICS

(At $T_A = +25^\circ\text{C}$, $V_S = 5\text{V}$, $V_{CM} = V_S/2$, $R_L = 600\Omega$, unless otherwise noted.)

PARAMETER	CONDITIONS	SGM8621/2/3/4						
		TYP	MIN/MAX OVER TEMPERATURE				UNITS	MIN/MAX
		+25°C	+25°C	-40°C to +85°C	-40°C to +125°C			
Input Characteristics								
Input Offset Voltage (V_{OS})		0.9	3	3.2	3.4	mV	MAX	
Input Bias Current (I_B)		1				pA	TYP	
Input Offset Current (I_{OS})		1				pA	TYP	
Input Common Mode Voltage Range (V_{CM})	$V_S = 5.5\text{V}$	-0.1 to 5.6				V	TYP	
Common Mode Rejection Ratio (CMRR)	$V_S = 5.5\text{V}$, $V_{CM} = -0.1\text{V}$ to 4V	82	65	64	63	dB	MIN	
	$V_S = 5.5\text{V}$, $V_{CM} = -0.1\text{V}$ to 5.6V	71	62	61	60	dB	MIN	
Open-Loop Voltage Gain (A_{OL})	$R_L = 600\Omega$, $V_{OUT} = 0.15\text{V}$ to 4.85V	90	80	75	68	dB	MIN	
	$R_L = 10\text{k}\Omega$, $V_{OUT} = 0.05\text{V}$ to 4.95V	100	89	85	83	dB	MIN	
Input Offset Voltage Drift ($\Delta V_{OS}/\Delta T$)		2.7				$\mu\text{V}/^\circ\text{C}$	TYP	
Output Characteristics								
Output Voltage Swing from Rail	$R_L = 600\Omega$	0.081				V	TYP	
	$R_L = 10\text{k}\Omega$	0.007				V	TYP	
Output Current (I_{OUT})		52	38	28	24	mA	MIN	
Closed-Loop Output Impedance	$f = 100\text{kHz}$, $G = 1$	10.8				Ω	TYP	
Power-Down Disable (SGM8623 Only)								
Turn-On Time		1.3				μs	TYP	
Turn-Off Time		0.3				μs	TYP	
$\overline{\text{DISABLE}}$ Voltage-Off			0.8			V	MAX	
$\overline{\text{DISABLE}}$ Voltage-On			2			V	MIN	
Power Supply								
Operating Voltage Range		2	2	2	2	V	MIN	
		5.5	5.5	5.5	5.5	V	MAX	
Power Supply Rejection Ratio (PSRR)	$V_S = 2\text{V}$ to 5.5V , $V_{CM} = (-V_S) + 0.5\text{V}$	85	68	66	65	dB	MIN	
Quiescent Current/ Amplifier (I_Q)	SGM8622/4 $I_{OUT} = 0$	210	300	340	360	μA	MAX	
	SGM8621/3 $I_{OUT} = 0$	270	370	420	450	μA	MAX	
Supply Current when Disabled (SGM8623 only)		0.47	8	9	10	μA	MAX	
Dynamic Performance								
Gain-Bandwidth Product (GBP)		3				MHz	TYP	
Phase Margin (ϕ_o)		73				$^\circ$	TYP	
Full Power Bandwidth (BW_P)	<1% distortion	50				kHz	TYP	
Slew Rate (SR)	$G = 1$, 2V output step	1.7				$\text{V}/\mu\text{s}$	TYP	
Settling Time to 0.1% (t_s)	$G = 1$, 2V output step	0.5				μs	TYP	
Overload Recovery Time	$V_{IN} \times G = V_S$	2.3				μs	TYP	
Noise Performance								
Input Voltage Noise Density (e_n)	$f = 1\text{kHz}$	17.5				$\text{nV}/\sqrt{\text{Hz}}$	TYP	

TYPICAL PERFORMANCE CHARACTERISTICS

At $T_A = +25^\circ\text{C}$, $V_{CM} = V_S/2$, $R_L = 600\Omega$, unless otherwise noted.

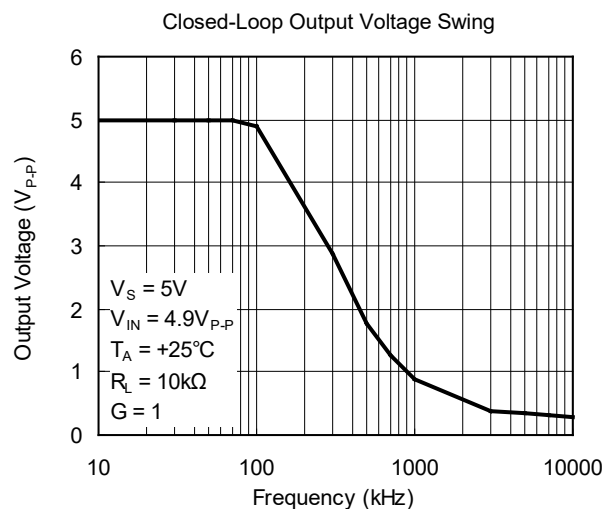
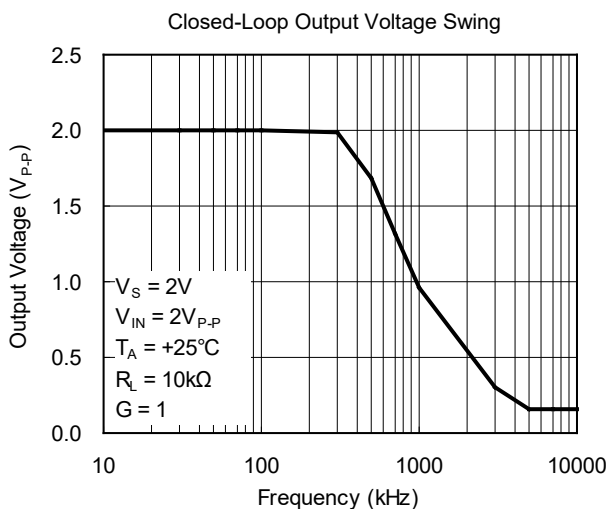
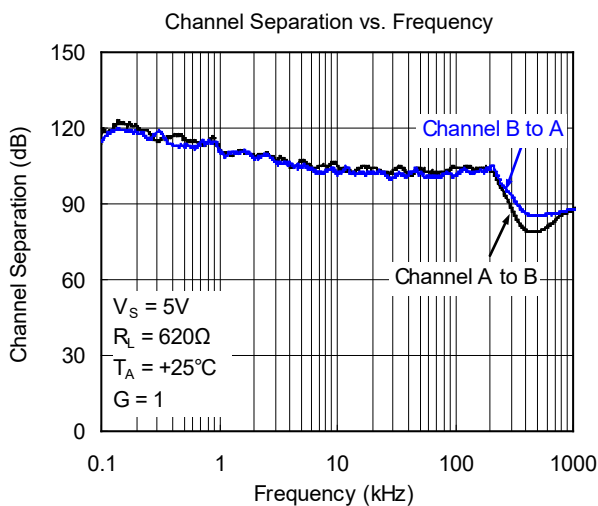
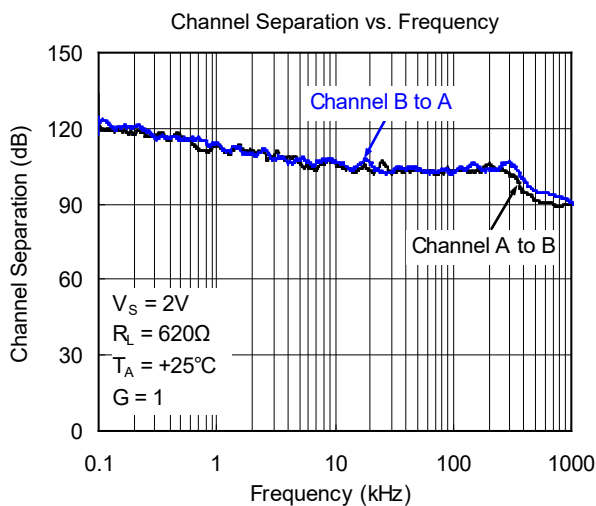
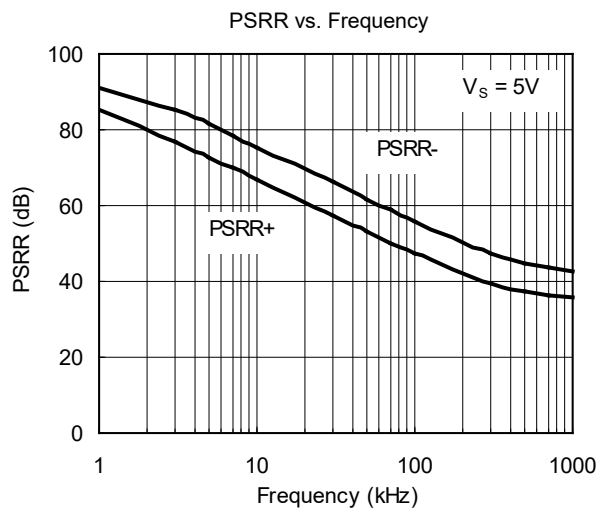
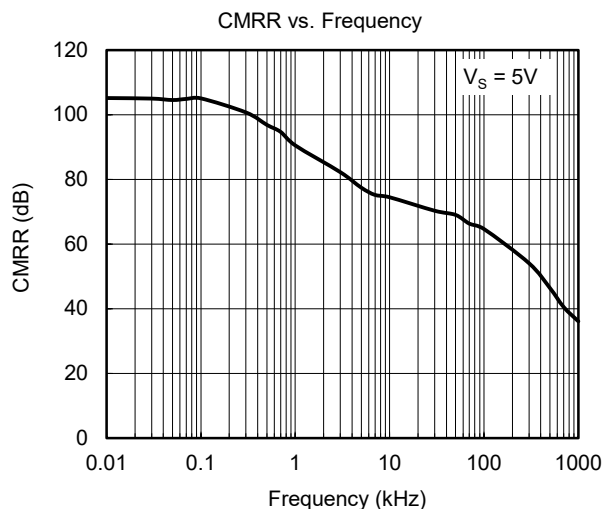

TYPICAL PERFORMANCE CHARACTERISTICS (continued)

At $T_A = +25^\circ\text{C}$, $V_{CM} = V_S/2$, $R_L = 600\Omega$, unless otherwise noted.

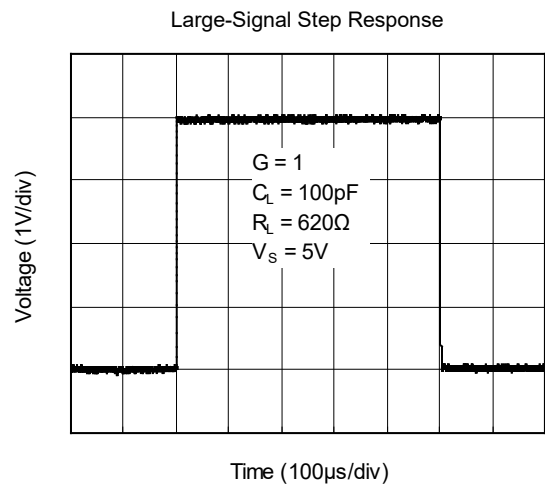
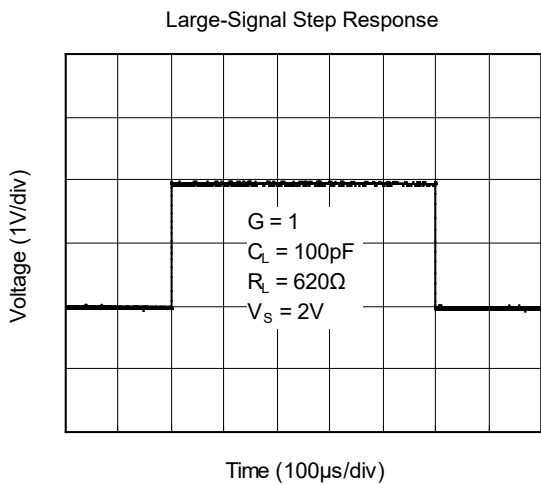
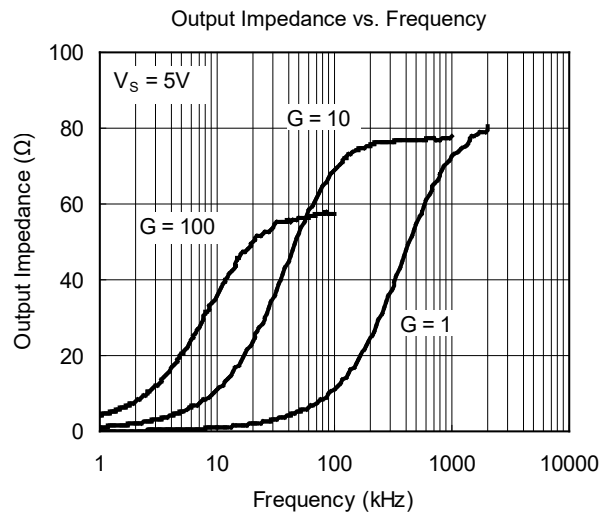
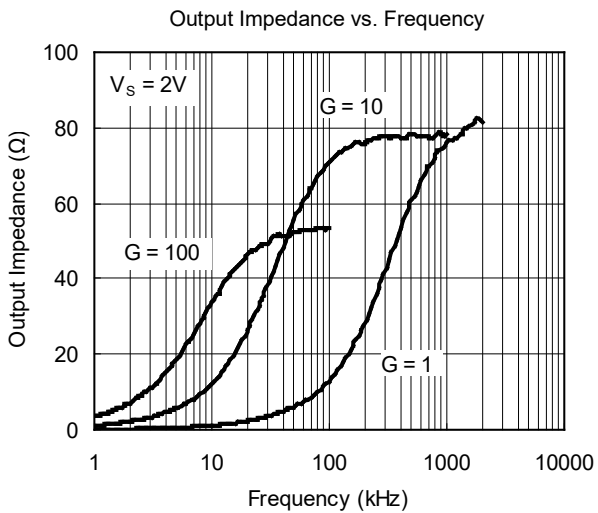
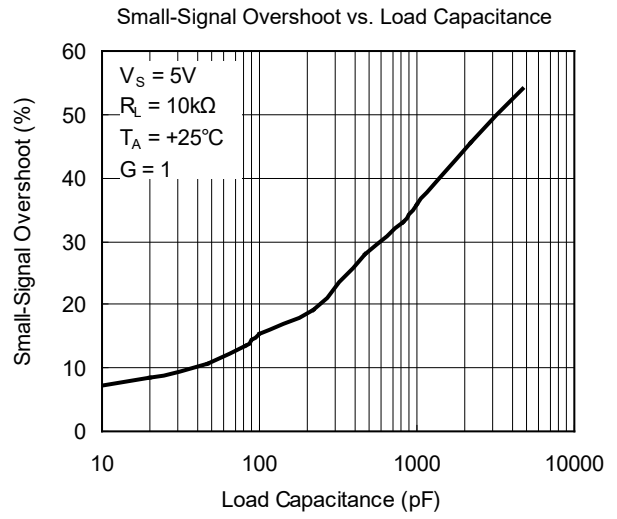
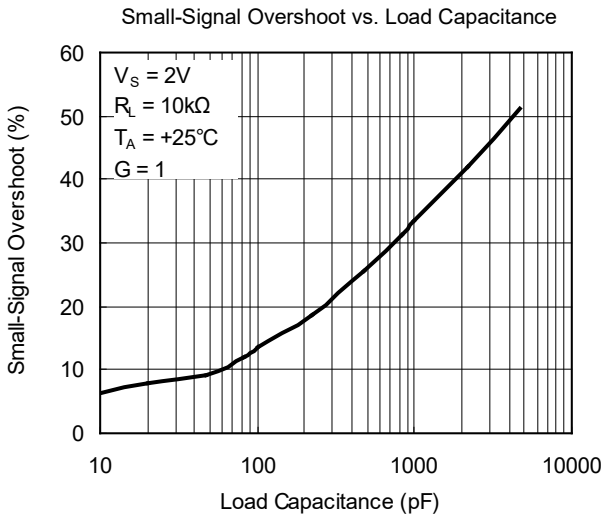

TYPICAL PERFORMANCE CHARACTERISTICS (continued)

At $T_A = +25^\circ\text{C}$, $V_{CM} = V_S/2$, $R_L = 600\Omega$, unless otherwise noted.

Small-Signal Step Response

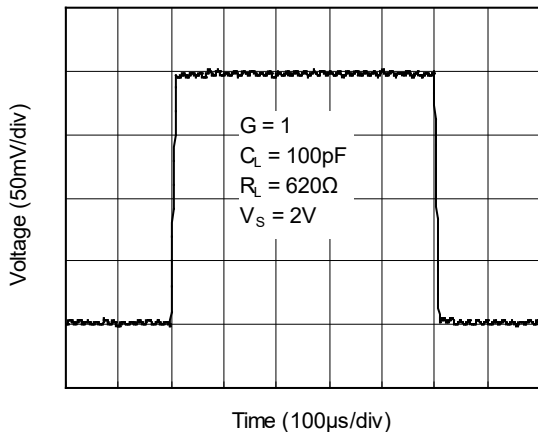

Small-Signal Step Response

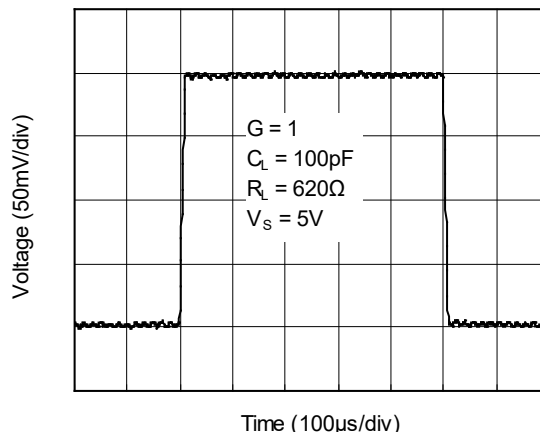

Positive Overload Recovery

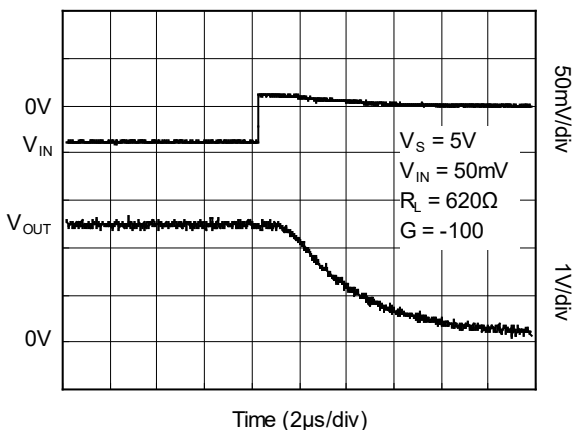

Negative Overload Recovery

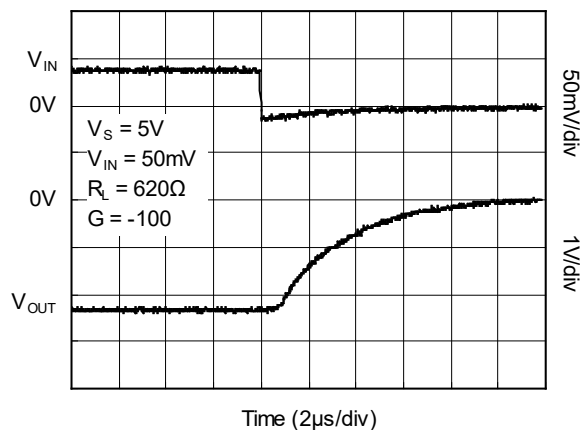

Supply Current vs. Temperature

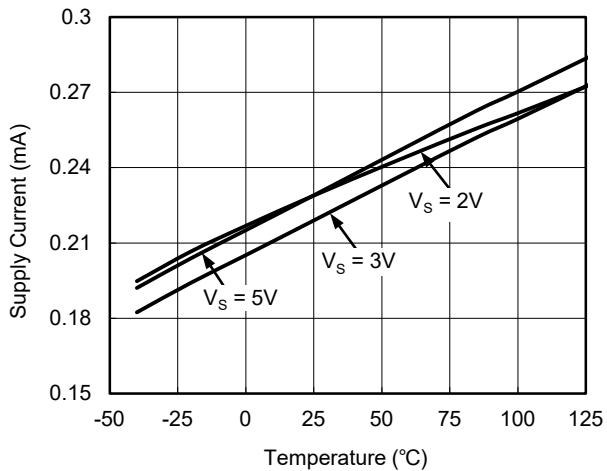

Shutdown Current vs. Temperature

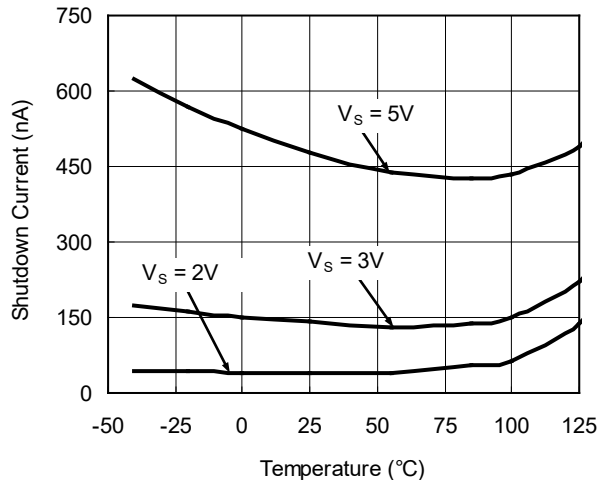

TYPICAL PERFORMANCE CHARACTERISTICS (continued)

At $T_A = +25^\circ\text{C}$, $V_{CM} = V_S/2$, $R_L = 600\Omega$, unless otherwise noted.

CMRR vs. Temperature

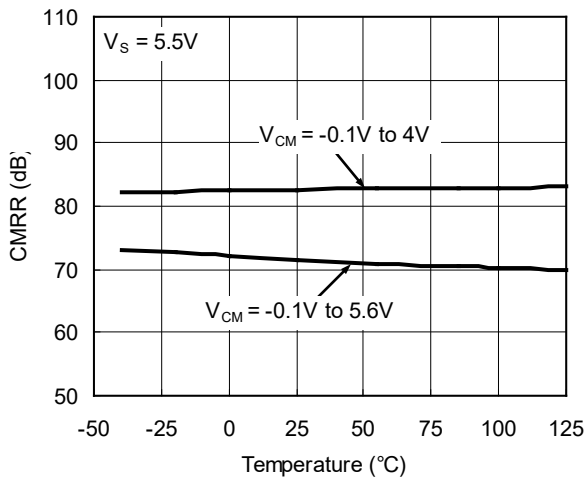

PSRR vs. Temperature

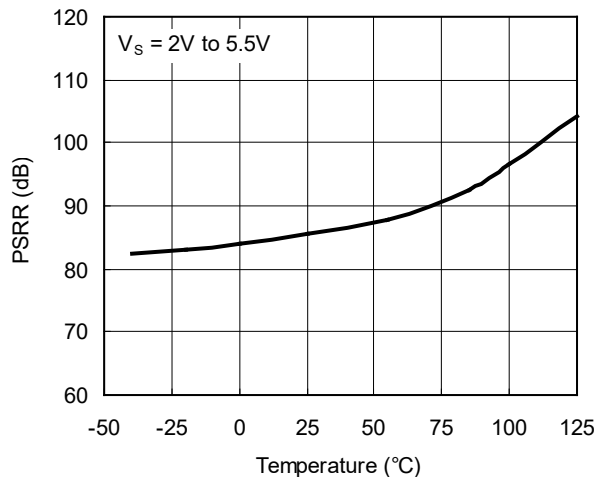

Open-Loop Voltage Gain vs. Temperature

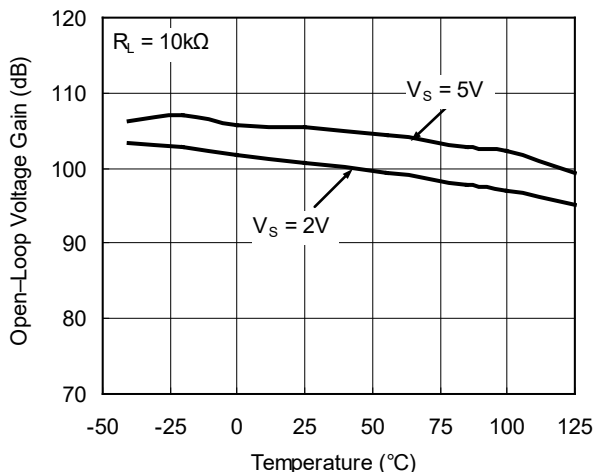

Open-Loop Voltage Gain vs. Temperature

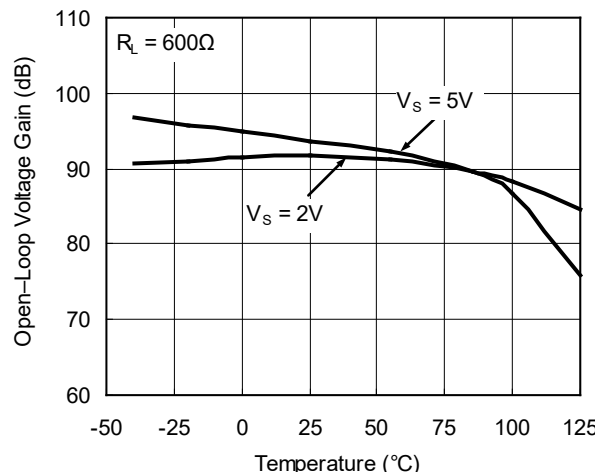

Output Voltage Swing vs. Output Current

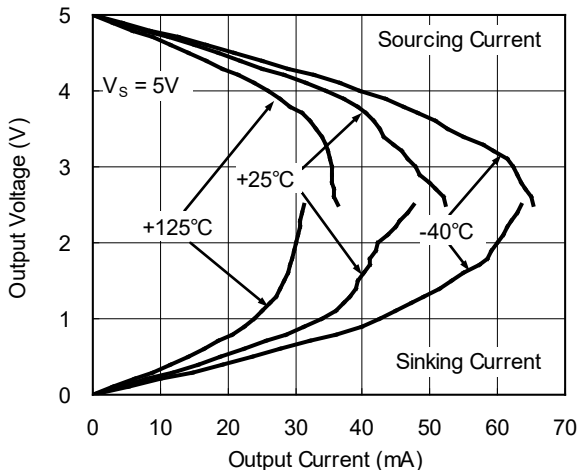

Output Voltage Swing vs. Output Current

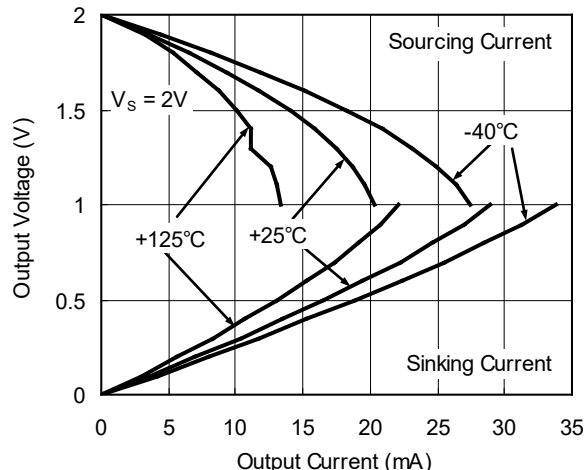

TYPICAL PERFORMANCE CHARACTERISTICS (continued)

At $T_A = +25^\circ\text{C}$, $V_{CM} = V_S/2$, $R_L = 600\Omega$, unless otherwise noted.

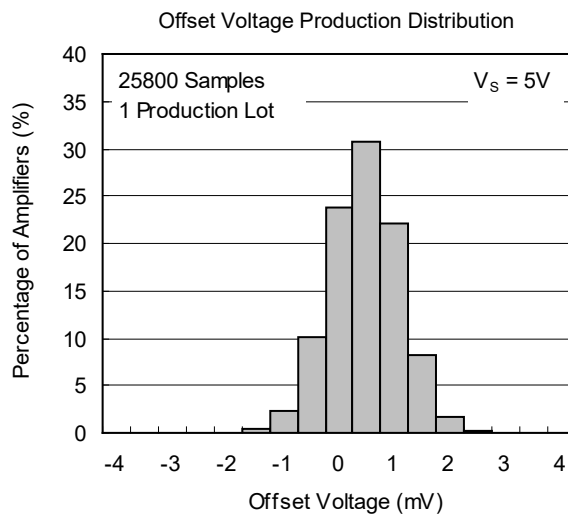
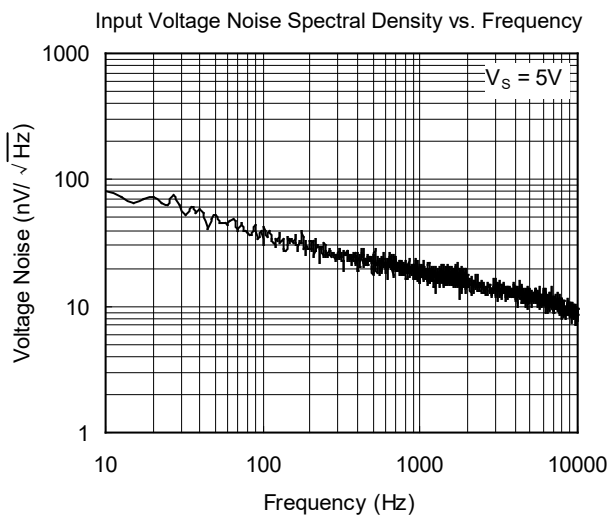

REVISION HISTORY

NOTE: Page numbers for previous revisions may differ from page numbers in the current version.

	Page
<hr/>	
JULY 2016 – REV.B.3 to REV.B.4	
Updated Electrical Characteristics section	5
<hr/>	
AUGUST 2015 – REV.B.3 to REV.B.4	Page
New Version	All
<hr/>	
JANUARY 2013 – REV.B.2 to REV.B.3	Page
Updated Package Outline Dimensions section	11 - 17
Added Tape and Reel Information section	18, 19
<hr/>	
MAY 2011 – REV.B.1 to REV.B.2	Page
Changed packages' name	All
<hr/>	
APRIL 2009 – REV.B to REV.B.1	Page
Changed SGM8624 packages	All
<hr/>	
AUGUST 2008 – REV.A to REV.B	Page
SGM8621 Added SC70-5 package	All
Changed Absolute Maximum Ratings section	3
Updated Package Outline Dimensions section	10 - 16
<hr/>	
Changes from Original (NOVEMBER 2006) to REV.A	Page
Changed from product preview to production data	All
<hr/>	

PACKAGE OUTLINE DIMENSIONS

SC70-5

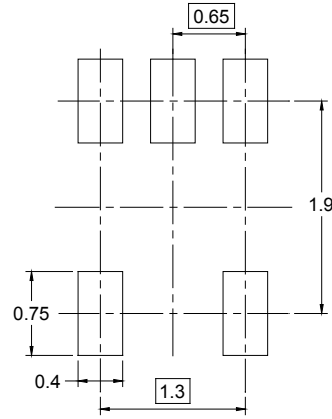
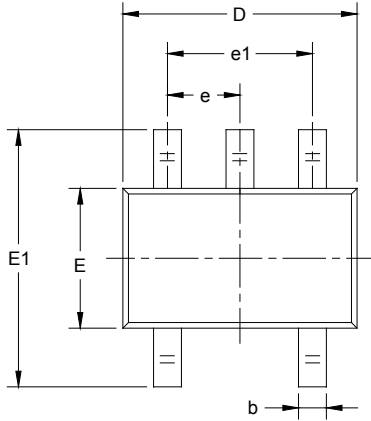

RECOMMENDED LAND PATTERN (Unit: mm)

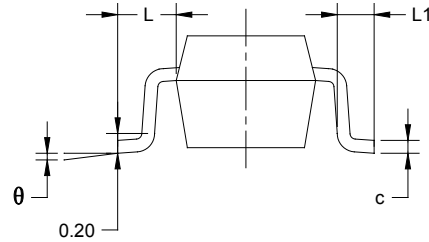
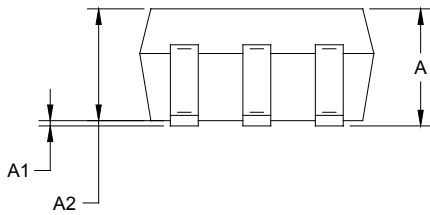

Symbol	Dimensions In Millimeters		Dimensions In Inches	
	MIN	MAX	MIN	MAX
A	0.900	1.100	0.035	0.043
A1	0.000	0.100	0.000	0.004
A2	0.900	1.000	0.035	0.039
b	0.150	0.350	0.006	0.014
c	0.080	0.150	0.003	0.006
D	2.000	2.200	0.079	0.087
E	1.150	1.350	0.045	0.053
E1	2.150	2.450	0.085	0.096
e	0.65 TYP		0.026 TYP	
e1	1.300 BSC		0.051 BSC	
L	0.525 REF		0.021 REF	
L1	0.260	0.460	0.010	0.018
θ	0°	8°	0°	8°

PACKAGE OUTLINE DIMENSIONS

SOT-23-5

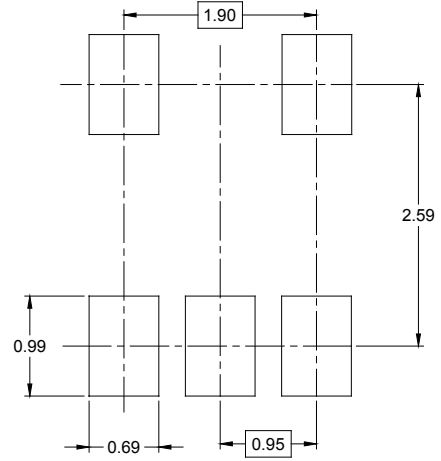
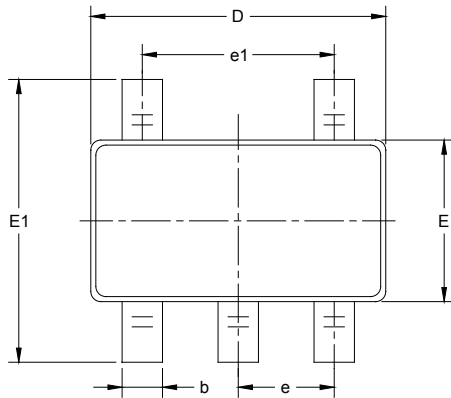

RECOMMENDED LAND PATTERN (Unit: mm)

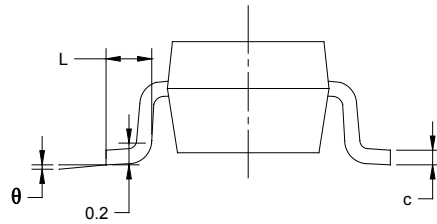
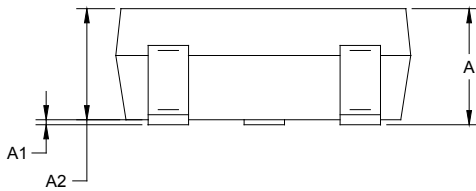

Symbol	Dimensions In Millimeters		Dimensions In Inches	
	MIN	MAX	MIN	MAX
A	1.050	1.250	0.041	0.049
A1	0.000	0.100	0.000	0.004
A2	1.050	1.150	0.041	0.045
b	0.300	0.500	0.012	0.020
c	0.100	0.200	0.004	0.008
D	2.820	3.020	0.111	0.119
E	1.500	1.700	0.059	0.067
E1	2.650	2.950	0.104	0.116
e	0.950 BSC		0.037 BSC	
e1	1.900 BSC		0.075 BSC	
L	0.300	0.600	0.012	0.024
θ	0°	8°	0°	8°

PACKAGE OUTLINE DIMENSIONS

SOT-23-6

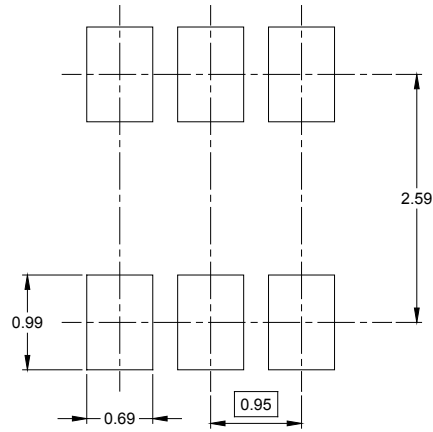
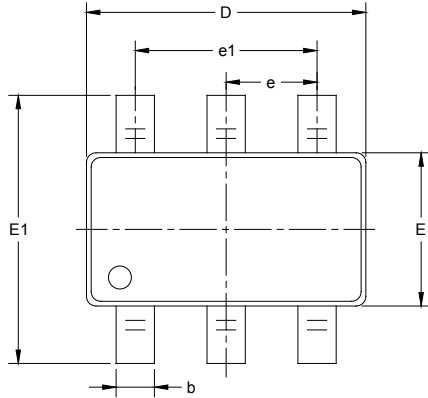

RECOMMENDED LAND PATTERN (Unit: mm)

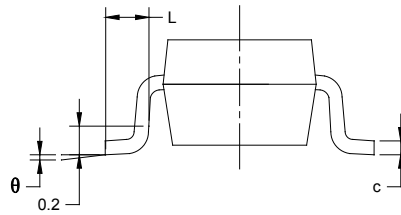
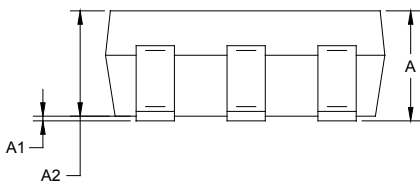

Symbol	Dimensions In Millimeters		Dimensions In Inches	
	MIN	MAX	MIN	MAX
A	1.050	1.250	0.041	0.049
A1	0.000	0.100	0.000	0.004
A2	1.050	1.150	0.041	0.045
b	0.300	0.500	0.012	0.020
c	0.100	0.200	0.004	0.008
D	2.820	3.020	0.111	0.119
E	1.500	1.700	0.059	0.067
E1	2.650	2.950	0.104	0.116
e	0.950 BSC		0.037 BSC	
e1	1.900 BSC		0.075 BSC	
L	0.300	0.600	0.012	0.024
θ	0°	8°	0°	8°

PACKAGE OUTLINE DIMENSIONS

SOIC-8

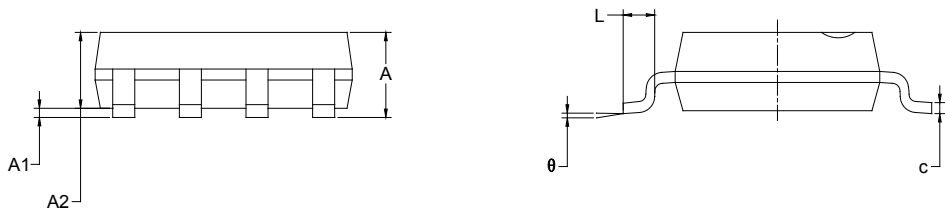
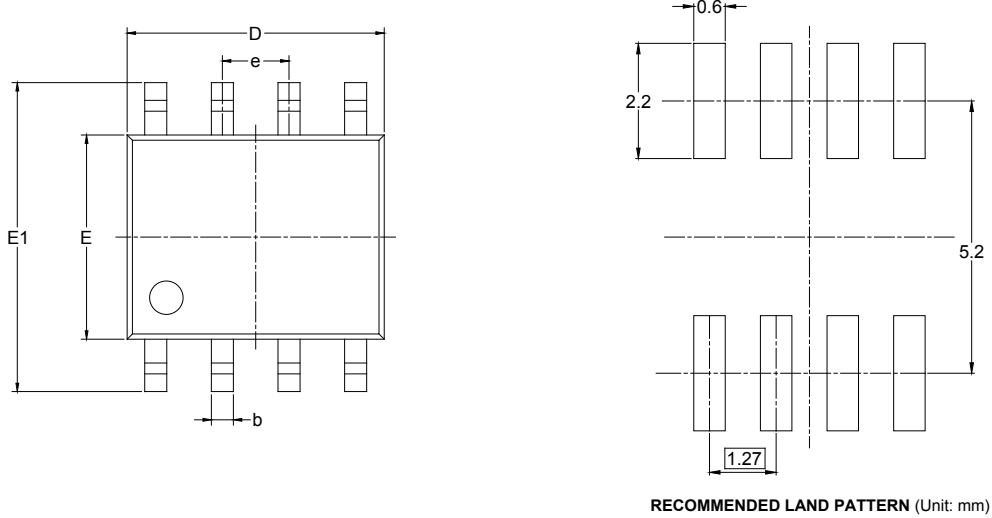

Symbol	Dimensions In Millimeters		Dimensions In Inches	
	MIN	MAX	MIN	MAX
A	1.350	1.750	0.053	0.069
A1	0.100	0.250	0.004	0.010
A2	1.350	1.550	0.053	0.061
b	0.330	0.510	0.013	0.020
c	0.170	0.250	0.006	0.010
D	4.700	5.100	0.185	0.200
E	3.800	4.000	0.150	0.157
E1	5.800	6.200	0.228	0.244
e	1.27 BSC		0.050 BSC	
L	0.400	1.270	0.016	0.050
θ	0°	8°	0°	8°

PACKAGE OUTLINE DIMENSIONS

MSOP-8

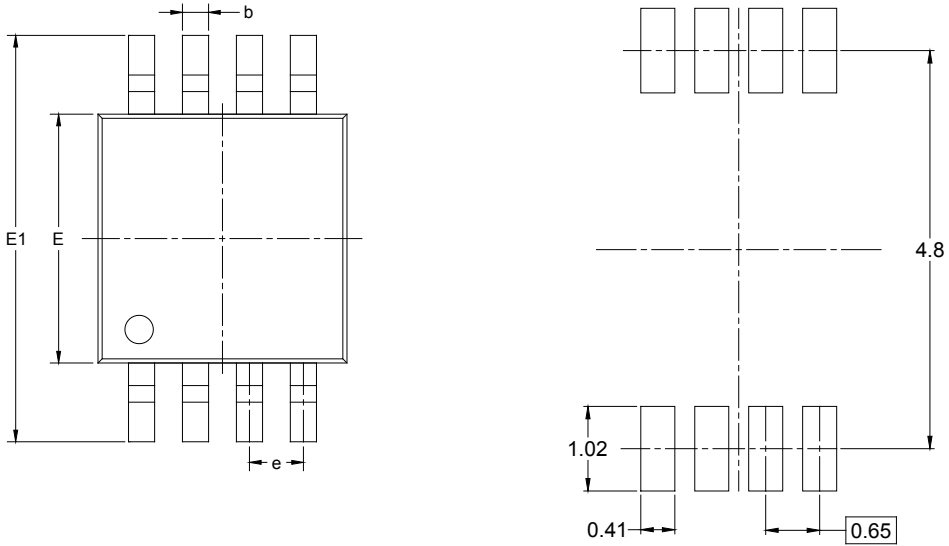

RECOMMENDED LAND PATTERN (Unit: mm)

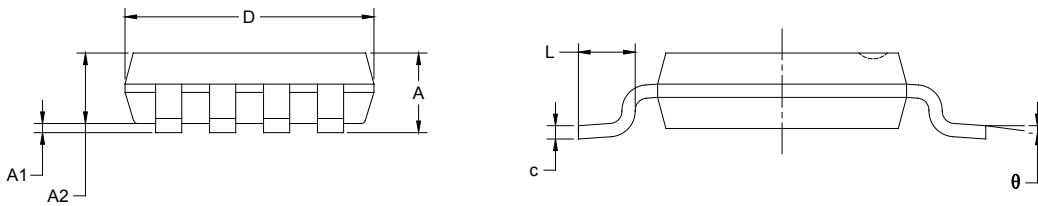

Symbol	Dimensions In Millimeters		Dimensions In Inches	
	MIN	MAX	MIN	MAX
A	0.820	1.100	0.032	0.043
A1	0.020	0.150	0.001	0.006
A2	0.750	0.950	0.030	0.037
b	0.250	0.380	0.010	0.015
c	0.090	0.230	0.004	0.009
D	2.900	3.100	0.114	0.122
E	2.900	3.100	0.114	0.122
E1	4.750	5.050	0.187	0.199
e	0.650 BSC		0.026 BSC	
L	0.400	0.800	0.016	0.031
θ	0°	6°	0°	6°

PACKAGE OUTLINE DIMENSIONS

SOIC-14

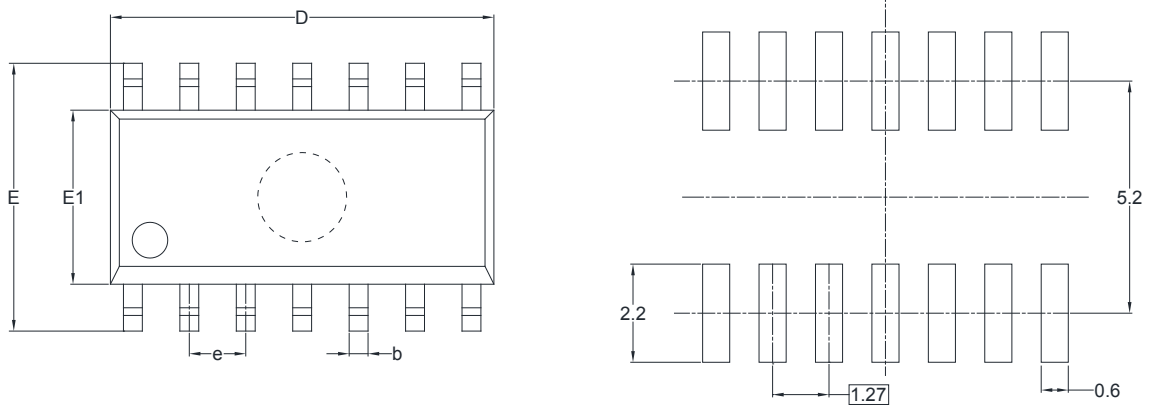

RECOMMENDED LAND PATTERN (Unit: mm)

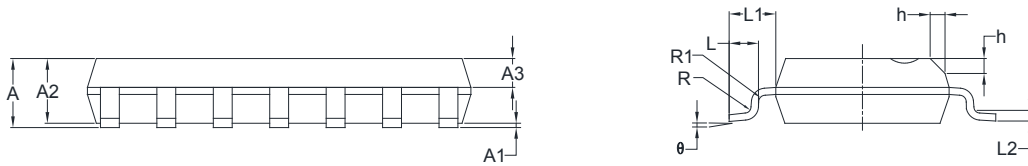

Symbol	Dimensions In Millimeters		Dimensions In Inches	
	MIN	MAX	MIN	MAX
A	1.35	1.75	0.053	0.069
A1	0.10	0.25	0.004	0.010
A2	1.25	1.65	0.049	0.065
A3	0.55	0.75	0.022	0.030
b	0.36	0.49	0.014	0.019
D	8.53	8.73	0.336	0.344
E	5.80	6.20	0.228	0.244
E1	3.80	4.00	0.150	0.157
e	1.27 BSC		0.050 BSC	
L	0.45	0.80	0.018	0.032
L1	1.04 REF		0.040 REF	
L2	0.25 BSC		0.01 BSC	
R	0.07		0.003	
R1	0.07		0.003	
h	0.30	0.50	0.012	0.020
θ	0°	8°	0°	8°

PACKAGE OUTLINE DIMENSIONS

TSSOP-14

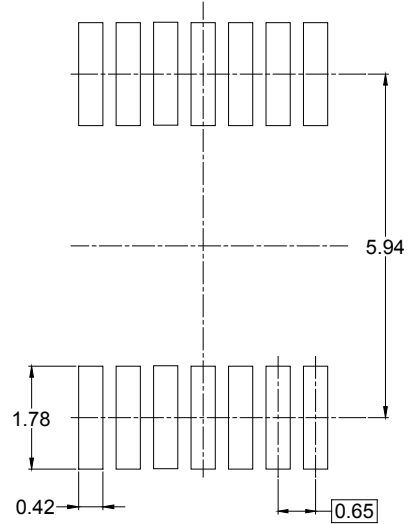
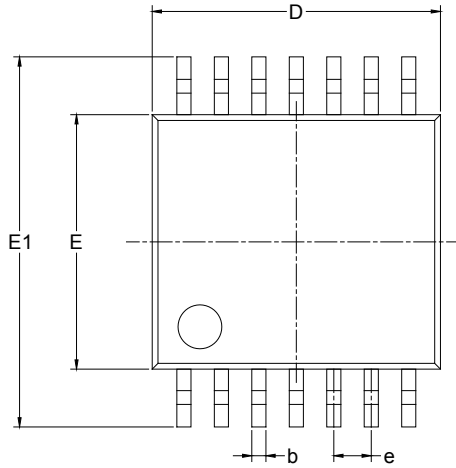

RECOMMENDED LAND PATTERN (Unit: mm)

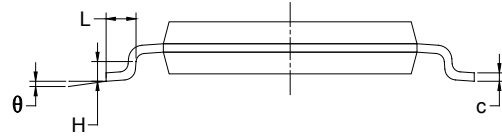
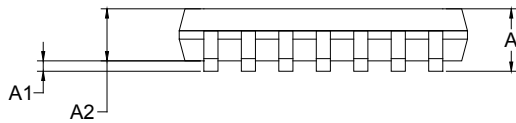

Symbol	Dimensions In Millimeters		Dimensions In Inches	
	MIN	MAX	MIN	MAX
A		1.200		0.047
A1	0.050	0.150	0.002	0.006
A2	0.800	1.050	0.031	0.041
b	0.190	0.300	0.007	0.012
c	0.090	0.200	0.004	0.008
D	4.860	5.100	0.191	0.201
E	4.300	4.500	0.169	0.177
E1	6.250	6.550	0.246	0.258
e	0.650 BSC		0.026 BSC	
L	0.500	0.700	0.02	0.028
H	0.25 TYP		0.01 TYP	
θ	1°	7°	1°	7°

PACKAGE INFORMATION

TAPE AND REEL INFORMATION

REEL DIMENSIONS

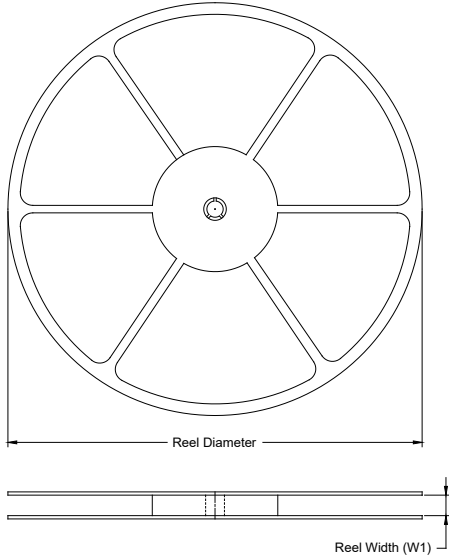

TAPE DIMENSIONS

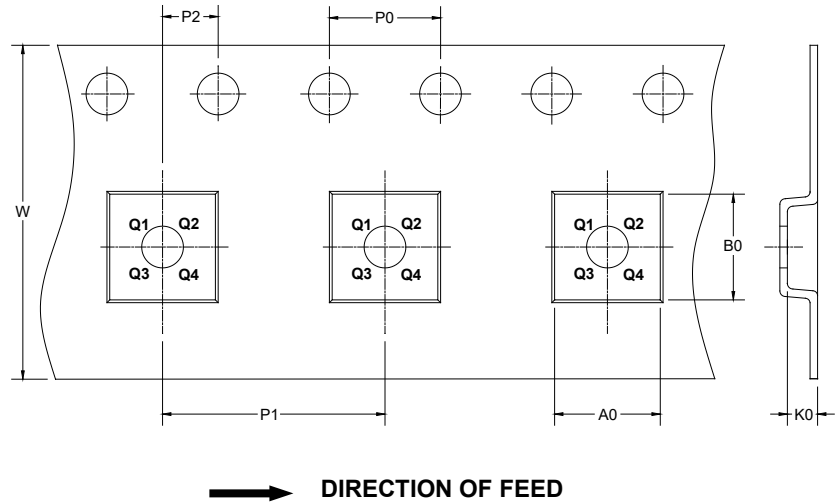

NOTE: The picture is only for reference. Please make the object as the standard.

KEY PARAMETER LIST OF TAPE AND REEL

Package Type	Reel Diameter	Reel Width W1 (mm)	A0 (mm)	B0 (mm)	K0 (mm)	P0 (mm)	P1 (mm)	P2 (mm)	W (mm)	Pin1 Quadrant
SC70-5	7"	9.5	2.25	2.55	1.20	4.0	4.0	2.0	8.0	Q3
SOT-23-5	7"	9.5	3.20	3.20	1.40	4.0	4.0	2.0	8.0	Q3
SOT-23-6	7"	9.5	3.17	3.23	1.37	4.0	4.0	2.0	8.0	Q3
SOIC-8	13"	12.4	6.40	5.40	2.10	4.0	8.0	2.0	12.0	Q1
MSOP-8	13"	12.4	5.20	3.30	1.50	4.0	8.0	2.0	12.0	Q1
SOIC-14	13"	16.4	6.60	9.30	2.10	4.0	8.0	2.0	16.0	Q1
TSSOP-14	13"	12.4	6.95	5.60	1.20	4.0	8.0	2.0	12.0	Q1

D00001

PACKAGE INFORMATION

CARTON BOX DIMENSIONS



NOTE: The picture is only for reference. Please make the object as the standard.

KEY PARAMETER LIST OF CARTON BOX

Reel Type	Length (mm)	Width (mm)	Height (mm)	Pizza/Carton
7" (Option)	368	227	224	8
7"	442	410	224	18
13"	386	280	370	5

DD0002